



Miniature Circuit Breakers & Residual Current Devices

BKN / BKN-b / BKN-c / BKH / BKP / BFN /
RKN / RKN-b / RKS / RKS-b / RKP / 32KGR / 32GRh / BS

MCB



Miniature Circuit Breakers & Residual Current Devices



Contents:



Quick selection table

- MCB	6
- RCBO	8
- RCCB	9
- Isolators	9

Main characteristics

MCB-Miniature circuit breakers

- BKP, BKN, BKN-b, BKN-c, BKH, BFN	10
------------------------------------	----

RCBO-Residual current circuitbreakers with overcurrent protection

- RKP, RKS, RKS-b, 32KGR, 32GRh, BS	28
-------------------------------------	----

RCCB-Residual current circuit breakers

- RKN, RKN-b	35
--------------	----

Isolator

- BKD	39
-------	----

60mm depth miniature circuit breakers

- BF-a, BF-c	40
--------------	----

Standard busbars

42

Characteristics curves & temperature compensation 43

Overall dimensions

- BKN, BKN-c, BKN-b, BKH	46
- BKP, BFN, RKP, 32KGR	47
- RKS, RKS-b, RKN, RKN-b, BKD	48
- BF-a, BF-c, 32GRhc/d, BS	49



Environmental policy and

RoHS compliance

What is RoHS?

The RoHS (Restriction of Hazardous Substances) is an EU Directive that specifically identifies six key materials so that manufacturers are held responsible for ensuring that their products contain controlled concentrations of the six substances restricted by the Directive.

The Six Hazardous Substances: Below 1,000ppm of Lead (Pb), Mercury (Hg), Hexavalent Chromium (Cr+6), Polybrominated Biphenyls (PBB) and Polybrominated Biphenyl Ethers (PBDE), and below 100ppm of Cadmium (Cd).

▶ **RoHS : Directive on the Restriction of Hazardous Substances in the Electronic Equipment (Effective on February 13, 2003)**

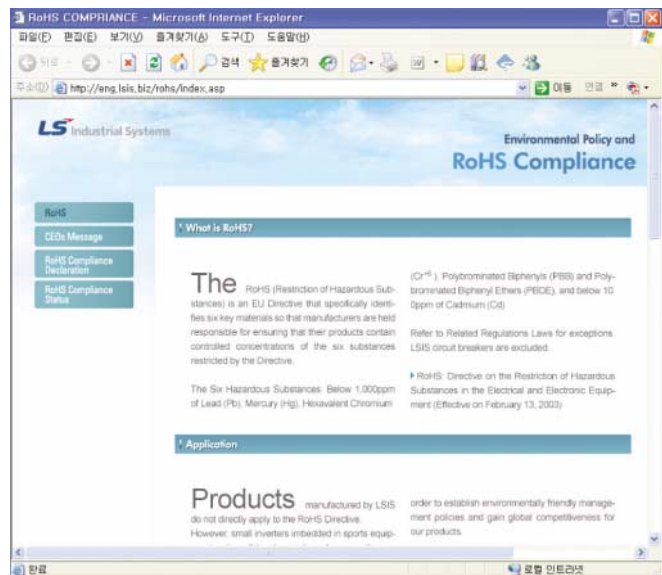

Application

Products manufactured by LSIS do not directly apply to the RoHS Directive.

However, small inverters imbedded in sport equipment and small breakers in large home appliances can be indirectly applied to the Directive.

LSIS continues to comply with the RoHS directive in order to establish environmentally Friendly management policies and global competitiveness for our products.

According to the Law, eight of the 10 WEEE products excluding 'medical equipment' and 'control systems' must be RoHS compliant.

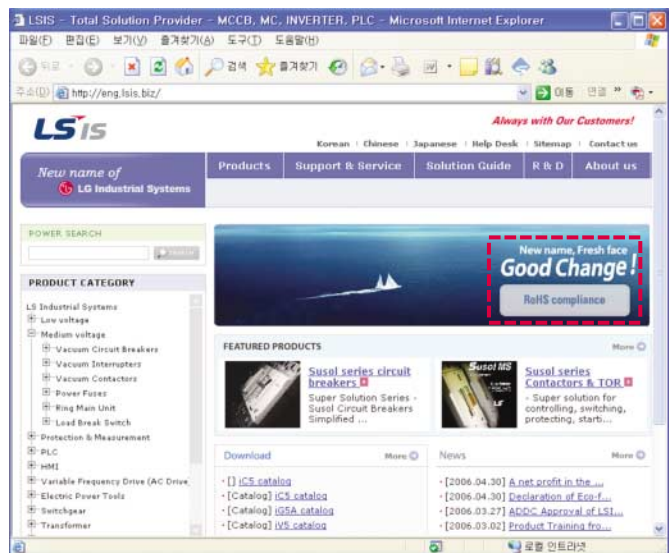

Declaration of RoHS Compliance

LS Industrial System Co.,Ltd
Yonsei Jaedan Severance Bldg.,84-11, Namdaemunno 5-ga,
Jung-gu, Seoul. 100-733, Korea (Manufacturer)

Do hereby confirm that

With relevance of the EU Directive 2002/95/EC of 27 January 2003 on the Restriction of the use of certain Hazardous Substances in electrical and electronic equipment –RoHS , our listed products do not contain any of the following banned substances listed below :

Lead
Mercury
Cadmium
Hexavalent Chromium
Polybrominated Biphenyls (PBB)
Polybrominated Diphenyl Ethers (PBDE)

The following products sold as of July 1, 2006 will be RoHS compliant.

Products Note)

Molded Case Circuit Breaker (MCCB) *
Earth Leakage Circuit Breaker (ELCB)
Magnetic Switch (MC,TOR)
Manual Motor Starter (MMS)
Protection & Measurement device
Programmable Logic Controller (PLC)
Variable Frequency Drive (AC Driver)

Note) Please visit www.lsis.biz and see "RoHS Compliance" menu to verify the specification of each product's "RoHS Compliance"

* Miniature Circuit Breaker [MCB] is included in the category of Molded Case Circuit Break [MCCB]

Place/Date : Korea/ April 4, 2006



LSIS Co., Ltd.

President & CEO **Ja-Kyun Koo**



Miniature circuit breakers

1, 2, 3 and 4 Pole Series up to 125AF [IEC 60898, IEC 60947-2]

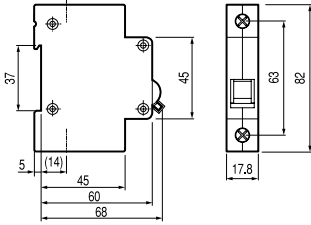
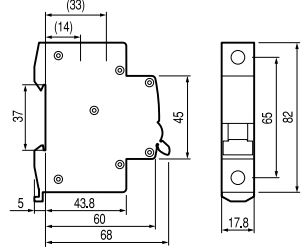

Type	MCB			
	BKN		BKN-b	
Protection	Overload and short circuit		Overload and short circuit	
Rated current	1, 2, 3, 4, 6, 10, 16, 20, 25, 32, 40, 50, 63A		1, 2, 3, 4, 6, 10, 16, 20, 25, 32, 40, 50, 63A	
Characteristic	B, C, D curve		B, C, D curve	
Poles	1p, 1p+N, 2p, 3p, 3p+N, 4p		1p, 1p+N, 2p, 3p, 3p+N, 4p	
Breaking capacity	1pole	2~4pole	1pole	2~4pole
	1A ~ 63A 6kA at 230/400VAC	1A ~ 63A 6kA at 400VAC	1A ~ 63A 10kA at 230/400VAC	1A ~ 63A 10kA at 400VAC
Standard	IEC 60898		IEC 60898	
Approval	CCC, SABS, SEMKO CB		CCC †, KEMA CB, SABS, SEMKO CB, UL 1077 †	
Type of trip	Thermal magnetic release		Thermal magnetic release	
Electrical endurance	6,000 operations		8,000 operations	
Mount	On 35mm DIN rail		On 35mm DIN rail	
Width	17.8mm per pole		17.8mm per pole	
Terminal	Lug type(cable up to 25mm ²)	Dual type(Lug & Screw)	Lug type(cable up to 25mm ²)	
Auxiliary switch, AX & AL Optional	 <p>1 changeover contact 6A at 240VAC, 3A at 415VAC(AX) 6A at 230VAC, 3A at 415VAC(AL) 2A at 48VDC, 1A at 125VDC Lug terminal Cable capacity 2.5mm² 9mm wide</p>		 <p>1 changeover contact 6A at 240VAC, 3A at 415VAC(AX/AL) 6A at 24VDC, 2A at 48VDC, 1A at 130VDC Lug terminal cable capacity 0.75~2.5mm² 8.8mm wide</p>	
Dimension				
Characteristic curve	See page 43		See page 43	
Remarks			† UL 1077(240V 10kA)	



MCB							
BKH		BKP		BF-a	BF-c	BFN	
Overload and short circuit		Overload and short circuit		Overload and short circuit		Overload and short circuit	
63, 80, 100, 125A		3, 6, 10, 16, 20, 25, 32A		10~100A		5, 10, 15, 20, 30, 40, 50A	
C, D curve		B, C, D curve					
1p, 2p, 3p, 3p+N, 4p		1p+N		1P, 2P, 3P		1P, 2P, 3P	
1pole	2~4pole					1pole	2~3pole
63A ~ 125A 10kA at 230/400VAC		3A ~ 32A 4.5kA at 230VAC				5A ~ 50A 10kA at 230VAC	5A ~ 50A 10kA at 400VAC
IEC 60947-2		IEC 60898		IEC 60947-2		IEC 60947-2	
CCC, CQC CB†		CCC, CQC CB				SEMKO	
Thermal magnetic release		Thermal magnetic release		Thermal magnetic release		Thermal magnetic release	
6,000 operations		20,000 operations				10,000 operations	
On 35mm DIN rail		On 35mm DIN rail		Holder mounting (Bolt on with fixing brackets)		Plug-in	
27mm per pole		17.8mm		25mm per pole		25mm per pole	
Lug type(cable up to 50mm ²)		Lug type(cable up to 10mm ²)		Clamp type		Lug type (14-6 AWG.)	
See page 43		See page 43		See page 44		See page 45	
IEC 60947-2 (SABS)							

Residual current circuit breakers

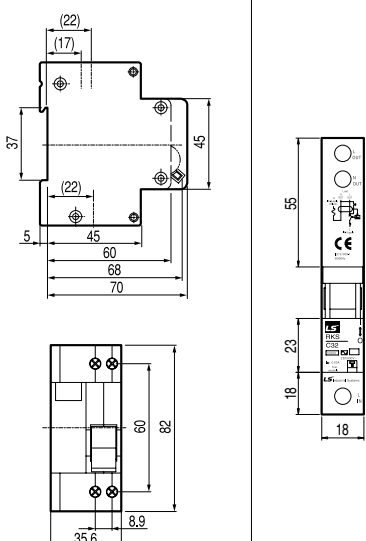
2 and 4pole series up to 63AF

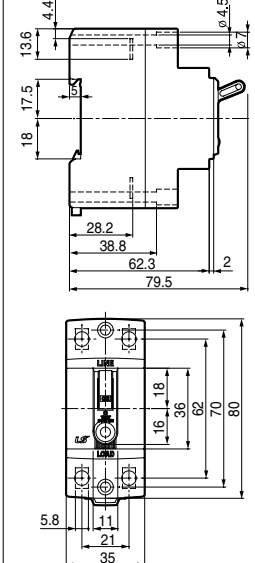
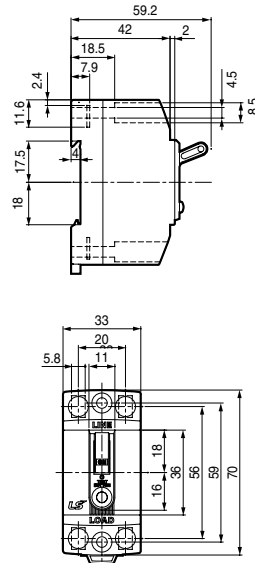
Type	RCBO						
	RKP	RKS	RKS-b	32KGRc	32KGRd	32GRhc	32GRhd
Protection	Ground fault and overcurrent	Ground fault and overcurrent		Ground fault and overcurrent		Ground fault and overcurrent	Ground fault and overcurrent
Rated current, I _n	3(B, C, D), 6, 10, 16, 20, 25, 32A (B, C, D curve)	6, 10, 16, 20, 25, 32, 40, 50A (B, C curve)		15, 20, 30A		15, 20, 30A	
Rated residual current							
Operating, I _{Δn}	15, 30, 100, 300mA(non-adjustable)	30, 100mA (non-adjustable)		15, 30mA(non-adjustable)		15, 30mA(non-adjustable)	
Non-operating, I _{Δno}	0.5I _{Δn}	0.5I _{Δn}		0.5I _{Δn}		0.5I _{Δn}	
Poles	1P+N	1P+N		2pole		2pole	
Rated voltage	230VAC	230VAC		110/220VAC		110/220VAC	
Residual current off-time	≤0.1 sec.	≤0.3sec.		≤0.03 sec.		≤0.03 sec.	
Standard	IEC 61009	IEC 61009		KS		KS	
Approval	CCC, CQC CB, CE	SEMKO CB, CE		KERI, CE		KERI, CE	
Type of trip							
Ground fault	Electronic	Electronic		Electronic		Electronic	
Overcurrent	Thermal-magnetic	Thermal-magnetic		Bimetallic		Bimetallic	
Breaking capacity	4.5kA	10kA		1.5kA	2.5kA	1.5kA	2.5kA
Conditional short circuit capacity	-	-		-		-	
Electrical endurance	20,000 operations	4,000 operations		6,000 operations		6,000 operations	
Mount	On 35mm DIN rail	On 35mm DIN rail		On 35mm DIN rail / Screw		On 35mm DIN rail / Screw	
Width	35.6mm	18mm		35mm		33mm	
Terminal	Lug type(cable up to 10mm ²)	Lug type(cable up to 10mm ²)		Screw clamp type(cable up to 5.5mm ²)		Screw clamp type(cable up to 5.5mm ²)	
Type of operation	-	-		-		-	
Dimension							
Characteristic curve	See page 43	See page 43		See page 43		See page 44	



		RCCB	
BS32c	BS32d	RKN	RKN-b
Ground fault and overcurrent		Ground fault	
6, 10, 15, 20, 30A	10, 15, 20, 30A	25, 32, 40, 63A	25, 32, 40, 63, 80, 100A
15, 30mA(non-adjustable)		30, 100, 300mA(non-adjustable)	
0.5I _{Δn}		0.5I _{Δn}	
2pole		1P+N, 3P+N	
110/220VAC		230VAC(1p+N), 230/415VAC(3P+N)	
≤0.03 sec.		≤0.1 sec.	
KS C 8321		IEC 61008	
KS		KEMA, CE	SEMKO, CE
Electronic		Electro-magnetic	
Bimetallic		N.A	
1.5kA	2.5kA	-	
-		6kA	10kA
6,000 operations		6,000 operations	
DIN rail / Screw		On 35mm DIN rail	
33mm		-	
Screw clamp type(cable up to 5.5mm ²)		Lug type(cable up to 35mm ²)	
-		A/AC	

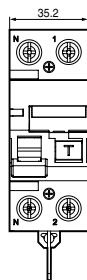
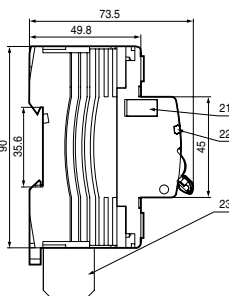
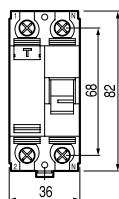
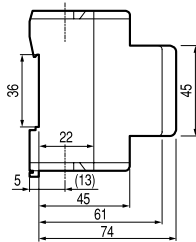
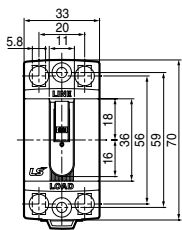
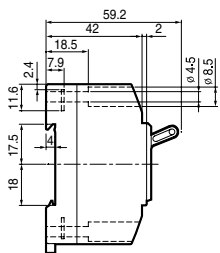

		Isolator
		BKD
Rated current, I_n		40, 50, 63, 80, 100, 125A
Poles		1p, 2p, 3p, 4p
Rated voltage		240/415VAC
Standard		IEC 60947-3
Approval		SABS
Electrical endurance	40, 50, 63A 80, 100, 125A	20000 operations 10000 operations
Mount		On 35mm DIN rail
Width		17.8mm per pole
Terminal		Lug type(cable up to 50mm ²)
Dimension		

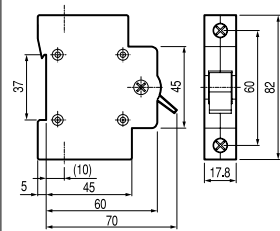

See page 45

Miniature circuit breakers

DIN rail mounting

CE 4500

BKP type



BKP 1P+N

Technical data

Standard	Confirming to IEC60898
Approval	CCC, CQC CB
Protection	Overload and short circuit
Rated current In	3, 6, 10, 16, 20, 25, 32A
Rated voltage	230VAC
Breaking capacity	4.5kA
Characteristic	B, C, D curve
Number of poles	1P+N
Type of trip	Thermal magnetic release
Type of terminal	Lug type
Terminal capacity	Cables up to 10mm ²
Installation	Mounting on 35mm DIN rail
Width	17.8mm per pole
Electrical endurance	20000 cycles

Certificate

CE

Catalog No.

Pole	Type	In	Model	Catalog No.	Pack. unit (Pcs.)	PRICE
1P+N	B curve	3A	BKP B3A	06120302R0	120	
		6A	BKP B6A	06120228R0	120	
		10A	BKP B10A	06120229R0	120	
		16A	BKP B16A	06120230R0	120	
		20A	BKP B20A	06120231R0	120	
		25A	BKP B25A	06120303R0	120	
		32A	BKP B32A	06120232R0	120	
		C curve	3A	BKP C3A	06120307R0	120
	6A		BKP C6A	06120235R0	120	
	10A		BKP C10A	06120236R0	120	
	16A		BKP C16A	06120237R0	120	
	20A		BKP C20A	06120238R0	120	
	25A		BKP C25A	06120309R0	120	
	32A		BKP C32A	06120239R0	120	
	D curve		3A	BKP D3A	06120308R0	120
		6A	BKP D6A	06120242R0	120	
		10A	BKP D10A	06120243R0	120	
		16A	BKP D16A	06120244R0	120	
		20A	BKP D20A	06120245R0	120	
		25A	BKP D25A	06120311R0	120	
		32A	BKP D32A	06120246R0	120	

BKN type



BKN 2P

Certificate

CE

Technical data

Standard	Confirming to IEC60898	
Approval	CCC, SABS, SEMKO CB, KEMA	
Protection	Against overload and short circuit	
Rated current In	1, 2, 3, 4, 6, 10, 16, 20, 25, 32, 40, 50, 63A	
Rated voltage	1pole 230/400VAC 50/60Hz 2, 3, 4pole 400VAC 50/60Hz	
Breaking capacity	6kA	
Characteristic	B, C, D curve	
Number of poles	1P, 1P+N, 2P, 3P, 3P+N and 4P	
Type of trip	Thermal-magnetic release	
Type of terminal	Lug type	
Terminal capacity	Cables up to 25mm ²	
Installation	Mounting on 35mm DIN rail	
Width	17.8mm per pole	
Electrical endurance		
In	1 ... 32A	40 ... 63A
Endurance	6000 cycles	6000 cycles
Max. frequency (Cycles/hour)	240	120



Optional accessories ... Auxiliary switch, AX

Composition	Consists of 1 changeover contact	
Rating	AC circuit	DC circuit
	6A at 240VAC 3A at 415VAC	2A at 48VDC 1A at 125VDC
Type of terminal	Lug type	
Terminal capacity	Cables up to 2.5mm ²	
Width	9mm	



Optional accessories ... Auxiliary switch, AL

Composition	Consists of 1 changeover contact	
Rating	AC circuit	DC circuit
	6A at 230VAC 3A at 415VAC	2A at 48VDC 1A at 125VDC
Type of terminal	Lug type	
Terminal capacity	Cables up to 2.5mm ²	
Width	9mm	

Miniature circuit breakers

DIN rail mounting

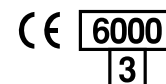

BKN type, B curve



BKN 1P



BKN 1P+N



BKN 2P

Catalog No.

6kA at 230/400VAC

In	Model	Catalog No.	Pack. unit (Pcs.)	PRICE
1A	BKN 1P B1A	06110086R0	120	
2A	BKN 1P B2A	06110087R0	120	
3A	BKN 1P B3A	06110088R0	120	
4A	BKN 1P B4A	06110089R0	120	
6A	BKN 1P B6A	06110090R0	120	
10A	BKN 1P B10A	06110091R0	120	
16A	BKN 1P B16A	06110092R0	120	
20A	BKN 1P B20A	06110093R0	120	
25A	BKN 1P B25A	06110094R0	120	
32A	BKN 1P B32A	06110095R0	120	
40A	BKN 1P B40A	06110096R0	120	
50A	BKN 1P B50A	06110097R0	120	
63A	BKN 1P B63A	06110098R0	120	

6kA at 230/400VAC

In	Model	Catalog No.	Pack. unit (Pcs.)	PRICE
1A	BKN 1P+N B1A	06120250R0	60	
2A	BKN 1P+N B2A	06120251R0	60	
3A	BKN 1P+N B3A	06120252R0	60	
4A	BKN 1P+N B4A	06120253R0	60	
6A	BKN 1P+N B6A	06120254R0	60	
10A	BKN 1P+N B10A	06120255R0	60	
16A	BKN 1P+N B16A	06120256R0	60	
20A	BKN 1P+N B20A	06120257R0	60	
25A	BKN 1P+N B25A	06120258R0	60	
32A	BKN 1P+N B32A	06120259R0	60	
40A	BKN 1P+N B40A	06120260R0	60	
50A	BKN 1P+N B50A	06120261R0	60	
63A	BKN 1P+N B63A	06120262R0	60	

6kA at 400VAC

In	Model	Catalog No.	Pack. unit (Pcs.)	PRICE
1A	BKN 2P B1A	06120263R0	60	
2A	BKN 2P B2A	06120264R0	60	
3A	BKN 2P B3A	06120265R0	60	
4A	BKN 2P B4A	06120266R0	60	
6A	BKN 2P B6A	06120267R0	60	
10A	BKN 2P B10A	06120268R0	60	
16A	BKN 2P B16A	06120269R0	60	
20A	BKN 2P B20A	06120270R0	60	
25A	BKN 2P B25A	06120271R0	60	
32A	BKN 2P B32A	06120272R0	60	
40A	BKN 2P B40A	06120273R0	60	
50A	BKN 2P B50A	06120274R0	60	
63A	BKN 2P B63A	06120275R0	60	

BKN type, B curve



BKN 3P



BKN 3P+N



BKN 4P



Catalog No.

6kA at 400VAC

In	Model	Catalog No.	Pack. unit (Pcs.)	PRICE
1A	BKN 3P B1A	06130066R0	40	
2A	BKN 3P B2A	06130067R0	40	
3A	BKN 3P B3A	06130068R0	40	
4A	BKN 3P B4A	06130069R0	40	
6A	BKN 3P B6A	06130070R0	40	
10A	BKN 3P B10A	06130071R0	40	
16A	BKN 3P B16A	06130072R0	40	
20A	BKN 3P B20A	06130073R0	40	
25A	BKN 3P B25A	06130074R0	40	
32A	BKN 3P B32A	06130075R0	40	
40A	BKN 3P B40A	06130076R0	40	
50A	BKN 3P B50A	06130077R0	40	
63A	BKN 3P B63A	06130078R0	40	

6kA at 400VAC

In	Model	Catalog No.	Pack. unit (Pcs.)	PRICE
1A	BKN 3P+N B1A	06140133R0	30	
2A	BKN 3P+N B2A	06140134R0	30	
3A	BKN 3P+N B3A	06140135R0	30	
4A	BKN 3P+N B4A	06140136R0	30	
6A	BKN 3P+N B6A	06140137R0	30	
10A	BKN 3P+N B10A	06140138R0	30	
16A	BKN 3P+N B16A	06140139R0	30	
20A	BKN 3P+N B20A	06140140R0	30	
25A	BKN 3P+N B25A	06140141R0	30	
32A	BKN 3P+N B32A	06140142R0	30	
40A	BKN 3P+N B40A	06140143R0	30	
50A	BKN 3P+N B50A	06140144R0	30	
63A	BKN 3P+N B63A	06140145R0	30	

6kA at 400VAC

In	Model	Catalog No.	Pack. unit (Pcs.)	PRICE
1A	BKN 4P B1A	06140146R0	30	
2A	BKN 4P B2A	06140147R0	30	
3A	BKN 4P B3A	06140148R0	30	
4A	BKN 4P B4A	06140149R0	30	
6A	BKN 4P B6A	06140150R0	30	
10A	BKN 4P B10A	06140151R0	30	
16A	BKN 4P B16A	06140152R0	30	
20A	BKN 4P B20A	06140153R0	30	
25A	BKN 4P B25A	06140154R0	30	
32A	BKN 4P B32A	06140155R0	30	
40A	BKN 4P B40A	06140156R0	30	
50A	BKN 4P B50A	06140157R0	30	
63A	BKN 4P B63A	06140158R0	30	

Auxiliary switch 1c contact

In	Model	Catalog No.	Pack. unit (Pcs.)	PRICE
6A	BKN-AX-6A	06150002R0		
6A	BKN-AL-6A	06150004R0		

Miniature circuit breakers

DIN rail mounting

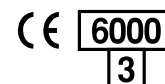

BKN type, C curve



BKN 1P



BKN 1P+N



BKN 2P

Catalog No.

6kA at 230/400VAC

In	Model	Catalog No.	Pack. unit (Pcs.)	PRICE
1A	BKN 1P C1A	06110070R0	120	
2A	BKN 1P C2A	06110071R0	120	
3A	BKN 1P C3A	06110072R0	120	
4A	BKN 1P C4A	06110073R0	120	
6A	BKN 1P C6A	06110074R0	120	
10A	BKN 1P C10A	06110075R0	120	
16A	BKN 1P C16A	06110076R0	120	
20A	BKN 1P C20A	06110077R0	120	
25A	BKN 1P C25A	06110078R0	120	
32A	BKN 1P C32A	06110079R0	120	
40A	BKN 1P C40A	06110080R0	120	
50A	BKN 1P C50A	06110081R0	120	
63A	BKN 1P C63A	06110082R0	120	

6kA at 230/400VAC

In	Model	Catalog No.	Pack. unit (Pcs.)	PRICE
1A	BKN 1P+N C1A	06120200R0	60	
2A	BKN 1P+N C2A	06120201R0	60	
3A	BKN 1P+N C3A	06120202R0	60	
4A	BKN 1P+N C4A	06120203R0	60	
6A	BKN 1P+N C6A	06120204R0	60	
10A	BKN 1P+N C10A	06120205R0	60	
16A	BKN 1P+N C16A	06120206R0	60	
20A	BKN 1P+N C20A	06120207R0	60	
25A	BKN 1P+N C25A	06120208R0	60	
32A	BKN 1P+N C32A	06120209R0	60	
40A	BKN 1P+N C40A	06120210R0	60	
50A	BKN 1P+N C50A	06120211R0	60	
63A	BKN 1P+N C63A	06120212R0	60	

6kA at 400VAC

In	Model	Catalog No.	Pack. unit (Pcs.)	PRICE
1A	BKN 2P C1A	06120213R0	60	
2A	BKN 2P C2A	06120214R0	60	
3A	BKN 2P C3A	06120215R0	60	
4A	BKN 2P C4A	06120216R0	60	
6A	BKN 2P C6A	06120217R0	60	
10A	BKN 2P C10A	06120218R0	60	
16A	BKN 2P C16A	06120219R0	60	
20A	BKN 2P C20A	06120220R0	60	
25A	BKN 2P C25A	06120221R0	60	
32A	BKN 2P C32A	06120222R0	60	
40A	BKN 2P C40A	06120223R0	60	
50A	BKN 2P C50A	06120224R0	60	
63A	BKN 2P C63A	06120225R0	60	

BKN type, C curve



BKN 3P



BKN 3P+N



BKN 4P



Catalog No.

6kA at 400VAC

In	Model	Catalog No.	Pack. unit (Pcs.)	PRICE
1A	BKN 3P C1A	06130050R0	40	
2A	BKN 3P C2A	06130051R0	40	
3A	BKN 3P C3A	06130052R0	40	
4A	BKN 3P C4A	06130053R0	40	
6A	BKN 3P C6A	06130054R0	40	
10A	BKN 3P C10A	06130055R0	40	
16A	BKN 3P C16A	06130056R0	40	
20A	BKN 3P C20A	06130057R0	40	
25A	BKN 3P C25A	06130058R0	40	
32A	BKN 3P C32A	06130059R0	40	
40A	BKN 3P C40A	06130060R0	40	
50A	BKN 3P C50A	06130061R0	40	
63A	BKN 3P C63A	06130062R0	40	

6kA at 400VAC

In	Model	Catalog No.	Pack. unit (Pcs.)	PRICE
1A	BKN 3P+N C1A	06140104R0	30	
2A	BKN 3P+N C2A	06140105R0	30	
3A	BKN 3P+N C3A	06140106R0	30	
4A	BKN 3P+N C4A	06140107R0	30	
6A	BKN 3P+N C6A	06140108R0	30	
10A	BKN 3P+N C10A	06140109R0	30	
16A	BKN 3P+N C16A	06140110R0	30	
20A	BKN 3P+N C20A	06140111R0	30	
25A	BKN 3P+N C25A	06140112R0	30	
32A	BKN 3P+N C32A	06140113R0	30	
40A	BKN 3P+N C40A	06140114R0	30	
50A	BKN 3P+N C50A	06140115R0	30	
63A	BKN 3P+N C63A	06140116R0	30	

6kA at 400VAC

In	Model	Catalog No.	Pack. unit (Pcs.)	PRICE
1A	BKN 4P C1A	06140117R0	30	
2A	BKN 4P C2A	06140118R0	30	
3A	BKN 4P C3A	06140119R0	30	
4A	BKN 4P C4A	06140120R0	30	
6A	BKN 4P C6A	06140121R0	30	
10A	BKN 4P C10A	06140122R0	30	
16A	BKN 4P C16A	06140123R0	30	
20A	BKN 4P C20A	06140124R0	30	
25A	BKN 4P C25A	06140125R0	30	
32A	BKN 4P C32A	06140126R0	30	
40A	BKN 4P C40A	06140127R0	30	
50A	BKN 4P C50A	06140128R0	30	
63A	BKN 4P C63A	06140129R0	30	

Auxiliary switch 1c contact

In	Model	Catalog No.	Pack. unit (Pcs.)	PRICE
6A	BKN-AX-6A	06150002R0		
6A	BKN-AL-6A	06150004R0		

Miniature circuit breakers

DIN rail mounting

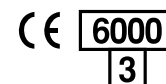

BKN type, D curve



BKN 1P



BKN 1P+N



BKN 2P

Catalog No.

6kA at 230/400VAC

In	Model	Catalog No.	Pack. unit (Pcs.)	PRICE
1A	BKN 1P D1A	06110099R0	120	
2A	BKN 1P D2A	06110100R0	120	
3A	BKN 1P D3A	06110101R0	120	
4A	BKN 1P D4A	06110102R0	120	
6A	BKN 1P D6A	06110103R0	120	
10A	BKN 1P D10A	06110104R0	120	
16A	BKN 1P D16A	06110105R0	120	
20A	BKN 1P D20A	06110106R0	120	
25A	BKN 1P D25A	06110107R0	120	
32A	BKN 1P D32A	06110108R0	120	
40A	BKN 1P D40A	06110109R0	120	
50A	BKN 1P D50A	06110110R0	120	
63A	BKN 1P D63A	06110111R0	120	

6kA at 230/400VAC

In	Model	Catalog No.	Pack. unit (Pcs.)	PRICE
1A	BKN 1P+N D1A	06120276R0	60	
2A	BKN 1P+N D2A	06120277R0	60	
3A	BKN 1P+N D3A	06120278R0	60	
4A	BKN 1P+N D4A	06120279R0	60	
6A	BKN 1P+N D6A	06120280R0	60	
10A	BKN 1P+N D10A	06120281R0	60	
16A	BKN 1P+N D16A	06120282R0	60	
20A	BKN 1P+N D20A	06120283R0	60	
25A	BKN 1P+N D25A	06120284R0	60	
32A	BKN 1P+N D32A	06120285R0	60	
40A	BKN 1P+N D40A	06120286R0	60	
50A	BKN 1P+N D50A	06120287R0	60	
63A	BKN 1P+N D63A	06120288R0	60	

6kA at 400VAC

In	Model	Catalog No.	Pack. unit (Pcs.)	PRICE
1A	BKN 2P D1A	06120289R0	60	
2A	BKN 2P D2A	06120290R0	60	
3A	BKN 2P D3A	06120291R0	60	
4A	BKN 2P D4A	06120292R0	60	
6A	BKN 2P D6A	06120293R0	60	
10A	BKN 2P D10A	06120294R0	60	
16A	BKN 2P D16A	06120295R0	60	
20A	BKN 2P D20A	06120296R0	60	
25A	BKN 2P D25A	06120297R0	60	
32A	BKN 2P D32A	06120298R0	60	
40A	BKN 2P D40A	06120299R0	60	
50A	BKN 2P D50A	06120300R0	60	
63A	BKN 2P D63A	06120301R0	60	

BKN type, D curve



BKN 3P



BKN 3P+N



BKN 4P



Catalog No.

6kA at 400VAC

In	Model	Catalog No.	Pack. unit (Pcs.)	PRICE
1A	BKN 3P D1A	06130079R0	40	
2A	BKN 3P D2A	06130080R0	40	
3A	BKN 3P D3A	06130081R0	40	
4A	BKN 3P D4A	06130082R0	40	
6A	BKN 3P D6A	06130083R0	40	
10A	BKN 3P D10A	06130084R0	40	
16A	BKN 3P D16A	06130085R0	40	
20A	BKN 3P D20A	06130086R0	40	
25A	BKN 3P D25A	06130087R0	40	
32A	BKN 3P D32A	06130088R0	40	
40A	BKN 3P D40A	06130089R0	40	
50A	BKN 3P D50A	06130090R0	40	
63A	BKN 3P D63A	06130091R0	40	

6kA at 400VAC

In	Model	Catalog No.	Pack. unit (Pcs.)	PRICE
1A	BKN 3P+N D1A	06140159R0	30	
2A	BKN 3P+N D2A	06140160R0	30	
3A	BKN 3P+N D3A	06140161R0	30	
4A	BKN 3P+N D4A	06140162R0	30	
6A	BKN 3P+N D6A	06140163R0	30	
10A	BKN 3P+N D10A	06140164R0	30	
16A	BKN 3P+N D16A	06140165R0	30	
20A	BKN 3P+N D20A	06140166R0	30	
25A	BKN 3P+N D25A	06140167R0	30	
32A	BKN 3P+N D32A	06140168R0	30	
40A	BKN 3P+N D40A	06140169R0	30	
50A	BKN 3P+N D50A	06140170R0	30	
63A	BKN 3P+N D63A	06140171R0	30	

6kA at 400VAC

In	Model	Catalog No.	Pack. unit (Pcs.)	PRICE
1A	BKN 4P D1A	06140172R0	30	
2A	BKN 4P D2A	06140173R0	30	
3A	BKN 4P D3A	06140174R0	30	
4A	BKN 4P D4A	06140175R0	30	
6A	BKN 4P D6A	06140176R0	30	
10A	BKN 4P D10A	06140177R0	30	
16A	BKN 4P D16A	06140178R0	30	
20A	BKN 4P D20A	06140179R0	30	
25A	BKN 4P D25A	06140180R0	30	
32A	BKN 4P D32A	06140181R0	30	
40A	BKN 4P D40A	06140182R0	30	
50A	BKN 4P D50A	06140183R0	30	
63A	BKN 4P D63A	06140184R0	30	

Auxiliary switch 1c contact

In	Model	Catalog No.	Pack. unit (Pcs.)	PRICE
6A	BKN-AX-6A	06150002R0		
6A	BKN-AL-6A	06150004R0		

Miniature circuit breakers

DIN rail mounting



High rupturing capacity

BKN-b type



BKN-b 2P

Certificate

CE

Patent protection

Technical data

Standard	Confirming to IEC60898	
Approval	CCC†, KEMA CB, SABS, SEMKO CB, UL 1077 †	
Protection	Against overload and short circuit	
Rated current In	1, 2, 3, 4, 6, 10, 16, 20, 25, 32, 40, 50, 63A	
Rated voltage	1pole 230/400VAC 50/60Hz 2, 3, 4pole 400VAC 50/60Hz	
Ambient temperature	-5°C to +40°C pursuant to IEC60898	
Breaking capacity	10kA	
Characteristic	B, C, D curve	
Number of poles	1P, 1P+N, 2P, 3P, 3P+N and 4P	
Type of trip	Thermal-magnetic release	
Type of terminal	Dual type (Lug & Screw)	
Terminal capacity	Cables up to 25mm ²	
Installation	Mounting on 35mm DIN rail	
Width	17.8mm per pole	
Electrical endurance		
In	1 ... 32A	40 ... 63A
Endurance	8000 cycles	8000 cycles
Max. frequency (Cycles/hour)	240	120

Influence of ambient temperature on nominal currents

Nominal current of MCB (A)	Internally resistance (mohm)	Power loss (W)	Max. impedance of impedance loop (Ohm)			Thermal correction of nominal currents				
			Character			Ambient temperature				
			B	C	D	20°C	30°C	40°C	50°C	60°C
1	1215.69	1.24	46.20	25.70	14.40	1.05	1	0.95	0.90	0.85
2	343.28	1.38	21.60	12.02	6.73	2.08	2	1.92	1.84	1.74
3	128.09	1.15	16.90	9.40	5.26	3.18	3	2.82	2.61	2.37
4	105.53	1.68	10.68	5.94	3.33	4.24	4	3.76	3.52	3.24
6	29.22	1.08	7.14	3.97	2.22	6.24	6	5.76	5.52	5.30
10	14.49	1.55	3.87	2.15	1.21	10.60	10	9.30	8.60	7.80
16	10.00	2.56	2.24	1.25	0.70	16.80	16	15.20	14.20	13.30
20	8.02	3.32	1.55	0.86	0.48	21.00	20	19.00	17.80	16.80
25	3.11	2.00	2.43	1.35	0.76	26.20	25	23.70	22.20	20.70
32	3.05	3.17	1.27	0.71	0.40	33.50	32	30.40	28.40	27.50
40	2.16	3.40	0.60	0.33	0.19	42.00	40	38.00	35.60	33.20
50	1.65	4.20	0.71	0.39	0.22	52.50	50	47.40	44.00	40.50
63	1.68	6.30	0.47	0.32	0.15	66.20	63	58.00	54.20	49.20

BKN-b type, B curve



BKN-b 1P

Catalog No.

10kA at 230/400VAC

In	Model	Catalog No.	Pack. unit (Pcs.)	PRICE
1A	BKN-b 1P B1A	06110160R0	120	
2A	BKN-b 1P B2A	06110161R0	120	
3A	BKN-b 1P B3A	06110162R0	120	
4A	BKN-b 1P B4A	06110163R0	120	
6A	BKN-b 1P B6A	06110164R0	120	
10A	BKN-b 1P B10A	06110165R0	120	
16A	BKN-b 1P B16A	06110166R0	120	
20A	BKN-b 1P B20A	06110167R0	120	
25A	BKN-b 1P B25A	06110168R0	120	
32A	BKN-b 1P B32A	06110169R0	120	
40A	BKN-b 1P B40A	06110170R0	120	
50A	BKN-b 1P B50A	06110171R0	120	
63A	BKN-b 1P B63A	06110172R0	120	



BKN-b 1P+N

10kA at 230/400VAC

In	Model	Catalog No.	Pack. unit (Pcs.)	PRICE
1A	BKN-b 1P+N B1A	06120417R0	60	
2A	BKN-b 1P+N B2A	06120418R0	60	
3A	BKN-b 1P+N B3A	06120419R0	60	
4A	BKN-b 1P+N B4A	06120420R0	60	
6A	BKN-b 1P+N B6A	06120421R0	60	
10A	BKN-b 1P+N B10A	06120422R0	60	
16A	BKN-b 1P+N B16A	06120423R0	60	
20A	BKN-b 1P+N B20A	06120424R0	60	
25A	BKN-b 1P+N B25A	06120425R0	60	
32A	BKN-b 1P+N B32A	06120426R0	60	
40A	BKN-b 1P+N B40A	06120427R0	60	
50A	BKN-b 1P+N B50A	06120428R0	60	
63A	BKN-b 1P+N B63A	06120429R0	60	



BKN-b 2P

10kA at 400VAC

In	Model	Catalog No.	Pack. unit (Pcs.)	PRICE
1A	BKN-b 2P B1A	06120430R0	60	
2A	BKN-b 2P B2A	06120431R0	60	
3A	BKN-b 2P B3A	06120432R0	60	
4A	BKN-b 2P B4A	06120433R0	60	
6A	BKN-b 2P B6A	06120434R0	60	
10A	BKN-b 2P B10A	06120435R0	60	
16A	BKN-b 2P B16A	06120436R0	60	
20A	BKN-b 2P B20A	06120437R0	60	
25A	BKN-b 2P B25A	06120438R0	60	
32A	BKN-b 2P B32A	06120439R0	60	
40A	BKN-b 2P B40A	06120440R0	60	
50A	BKN-b 2P B50A	06120441R0	60	
63A	BKN-b 2P B63A	06120442R0	60	

Miniature circuit breakers

DIN rail mounting



BKN-b type, B curve



BKN-b 3P

Catalog No.

10kA at 400VAC

In	Model	Catalog No.	Pack. unit (Pcs.)	PRICE
1A	BKN-b 3P B1A	06120443R0	40	
2A	BKN-b 3P B2A	06120444R0	40	
3A	BKN-b 3P B3A	06120445R0	40	
4A	BKN-b 3P B4A	06120446R0	40	
6A	BKN-b 3P B6A	06120447R0	40	
10A	BKN-b 3P B10A	06120448R0	40	
16A	BKN-b 3P B16A	06120449R0	40	
20A	BKN-b 3P B20A	06120450R0	40	
25A	BKN-b 3P B25A	06120451R0	40	
32A	BKN-b 3P B32A	06120452R0	40	
40A	BKN-b 3P B40A	06120453R0	40	
50A	BKN-b 3P B50A	06120454R0	40	
63A	BKN-b 3P B63A	06120455R0	40	



BKN-b 3P+N

10kA at 400VAC

In	Model	Catalog No.	Pack. unit (Pcs.)	PRICE
1A	BKN-b 3P+N B1A	06120456R0	30	
2A	BKN-b 3P+N B2A	06120457R0	30	
3A	BKN-b 3P+N B3A	06120458R0	30	
4A	BKN-b 3P+N B4A	06120459R0	30	
6A	BKN-b 3P+N B6A	06120460R0	30	
10A	BKN-b 3P+N B10A	06120461R0	30	
16A	BKN-b 3P+N B16A	06120462R0	30	
20A	BKN-b 3P+N B20A	06120463R0	30	
25A	BKN-b 3P+N B25A	06120464R0	30	
32A	BKN-b 3P+N B32A	06120465R0	30	
40A	BKN-b 3P+N B40A	06120466R0	30	
50A	BKN-b 3P+N B50A	06120467R0	30	
63A	BKN-b 3P+N B63A	06120468R0	30	



BKN-b 4P

10kA at 400VAC

In	Model	Catalog No.	Pack. unit (Pcs.)	PRICE
1A	BKN-b 4P B1A	06120469R0	30	
2A	BKN-b 4P B2A	06120470R0	30	
3A	BKN-b 4P B3A	06120471R0	30	
4A	BKN-b 4P B4A	06120472R0	30	
6A	BKN-b 4P B6A	06120473R0	30	
10A	BKN-b 4P B10A	06120474R0	30	
16A	BKN-b 4P B16A	06120475R0	30	
20A	BKN-b 4P B20A	06120476R0	30	
25A	BKN-b 4P B25A	06120477R0	30	
32A	BKN-b 4P B32A	06120478R0	30	
40A	BKN-b 4P B40A	06120479R0	30	
50A	BKN-b 4P B50A	06120480R0	30	
63A	BKN-b 4P B63A	06120481R0	30	

BKN-b type, C curve



BKN-b 1P

Catalog No.

10kA at 230/400VAC

In	Model	Catalog No.	Pack. unit (Pcs.)	PRICE
1A	BKN-b 1P C1A	06110173R0	120	
2A	BKN-b 1P C2A	06110174R0	120	
3A	BKN-b 1P C3A	06110175R0	120	
4A	BKN-b 1P C4A	06110176R0	120	
6A	BKN-b 1P C6A	06110177R0	120	
10A	BKN-b 1P C10A	06110178R0	120	
16A	BKN-b 1P C16A	06110179R0	120	
20A	BKN-b 1P C20A	06110180R0	120	
25A	BKN-b 1P C25A	06110181R0	120	
32A	BKN-b 1P C32A	06110182R0	120	
40A	BKN-b 1P C40A	06110183R0	120	
50A	BKN-b 1P C50A	06110184R0	120	
63A	BKN-b 1P C63A	06110185R0	120	



BKN-b 1P+N

10kA at 230/400VAC

In	Model	Catalog No.	Pack. unit (Pcs.)	PRICE
1A	BKN-b 1P+N C1A	06110186R0	60	
2A	BKN-b 1P+N C2A	06110187R0	60	
3A	BKN-b 1P+N C3A	06110188R0	60	
4A	BKN-b 1P+N C4A	06110189R0	60	
6A	BKN-b 1P+N C6A	06110190R0	60	
10A	BKN-b 1P+N C10A	06110191R0	60	
16A	BKN-b 1P+N C16A	06110192R0	60	
20A	BKN-b 1P+N C20A	06110193R0	60	
25A	BKN-b 1P+N C25A	06110194R0	60	
32A	BKN-b 1P+N C32A	06110195R0	60	
40A	BKN-b 1P+N C40A	06110196R0	60	
50A	BKN-b 1P+N C50A	06110197R0	60	
63A	BKN-b 1P+N C63A	06110198R0	60	



BKN-b 2P

10kA at 400VAC

In	Model	Catalog No.	Pack. unit (Pcs.)	PRICE
1A	BKN-b 2P C1A	06110199R0	60	
2A	BKN-b 2P C2A	06110200R0	60	
3A	BKN-b 2P C3A	06110201R0	60	
4A	BKN-b 2P C4A	06110202R0	60	
6A	BKN-b 2P C6A	06110203R0	60	
10A	BKN-b 2P C10A	06110204R0	60	
16A	BKN-b 2P C16A	06110205R0	60	
20A	BKN-b 2P C20A	06110206R0	60	
25A	BKN-b 2P C25A	06110207R0	60	
32A	BKN-b 2P C32A	06110208R0	60	
40A	BKN-b 2P C40A	06110209R0	60	
50A	BKN-b 2P C50A	06110210R0	60	
63A	BKN-b 2P C63A	06110211R0	60	

Miniature circuit breakers

DIN rail mounting



BKN-b type, C curve



BKN-b 3P

Catalog No.

10kA at 400VAC

In	Model	Catalog No.	Pack. unit (Pcs.)	PRICE
1A	BKN-b 3P C1A	06110212R0	40	
2A	BKN-b 3P C2A	06110213R0	40	
3A	BKN-b 3P C3A	06110214R0	40	
4A	BKN-b 3P C4A	06110215R0	40	
6A	BKN-b 3P C6A	06110216R0	40	
10A	BKN-b 3P C10A	06110217R0	40	
16A	BKN-b 3P C16A	06110218R0	40	
20A	BKN-b 3P C20A	06110219R0	40	
25A	BKN-b 3P C25A	06110220R0	40	
32A	BKN-b 3P C32A	06110221R0	40	
40A	BKN-b 3P C40A	06110222R0	40	
50A	BKN-b 3P C50A	06110223R0	40	
63A	BKN-b 3P C63A	06110224R0	40	



BKN-b 3P+N

10kA at 400VAC

In	Model	Catalog No.	Pack. unit (Pcs.)	PRICE
1A	BKN-b 3P+N C1A	06110225R0	30	
2A	BKN-b 3P+N C2A	06110226R0	30	
3A	BKN-b 3P+N C3A	06110227R0	30	
4A	BKN-b 3P+N C4A	06110228R0	30	
6A	BKN-b 3P+N C6A	06110229R0	30	
10A	BKN-b 3P+N C10A	06110230R0	30	
16A	BKN-b 3P+N C16A	06110231R0	30	
20A	BKN-b 3P+N C20A	06110232R0	30	
25A	BKN-b 3P+N C25A	06110233R0	30	
32A	BKN-b 3P+N C32A	06110234R0	30	
40A	BKN-b 3P+N C40A	06110235R0	30	
50A	BKN-b 3P+N C50A	06110236R0	30	
63A	BKN-b 3P+N C63A	06110237R0	30	



BKN-b 4P

10kA at 400VAC

In	Model	Catalog No.	Pack. unit (Pcs.)	PRICE
1A	BKN-b 4P C1A	06110238R0	30	
2A	BKN-b 4P C2A	06110239R0	30	
3A	BKN-b 4P C3A	06110240R0	30	
4A	BKN-b 4P C4A	06110241R0	30	
6A	BKN-b 4P C6A	06110242R0	30	
10A	BKN-b 4P C10A	06110243R0	30	
16A	BKN-b 4P C16A	06110244R0	30	
20A	BKN-b 4P C20A	06110245R0	30	
25A	BKN-b 4P C25A	06110246R0	30	
32A	BKN-b 4P C32A	06110247R0	30	
40A	BKN-b 4P C40A	06110248R0	30	
50A	BKN-b 4P C50A	06110249R0	30	
63A	BKN-b 4P C63A	06110250R0	30	

BKN-b type, D curve



BKN-b 1P

Catalog No.

10kA at 230/400VAC

In	Model	Catalog No.	Pack. unit (Pcs.)	PRICE
1A	BKN-b 1P D1A	06110251R0	120	
2A	BKN-b 1P D2A	06110252R0	120	
3A	BKN-b 1P D3A	06110253R0	120	
4A	BKN-b 1P D4A	06110254R0	120	
6A	BKN-b 1P D6A	06110255R0	120	
10A	BKN-b 1P D10A	06110256R0	120	
16A	BKN-b 1P D16A	06110257R0	120	
20A	BKN-b 1P D20A	06110258R0	120	
25A	BKN-b 1P D25A	06110259R0	120	
32A	BKN-b 1P D32A	06110260R0	120	
40A	BKN-b 1P D40A	06110261R0	120	
50A	BKN-b 1P D50A	06110262R0	120	
63A	BKN-b 1P D63A	06110263R0	120	



BKN-b 1P+N

10kA at 230/400VAC

In	Model	Catalog No.	Pack. unit (Pcs.)	PRICE
1A	BKN-b 1P+N D1A	06110264R0	60	
2A	BKN-b 1P+N D2A	06110265R0	60	
3A	BKN-b 1P+N D3A	06110266R0	60	
4A	BKN-b 1P+N D4A	06110267R0	60	
6A	BKN-b 1P+N D6A	06110268R0	60	
10A	BKN-b 1P+N D10A	06110269R0	60	
16A	BKN-b 1P+N D16A	06110270R0	60	
20A	BKN-b 1P+N D20A	06110271R0	60	
25A	BKN-b 1P+N D25A	06110272R0	60	
32A	BKN-b 1P+N D32A	06110273R0	60	
40A	BKN-b 1P+N D40A	06110274R0	60	
50A	BKN-b 1P+N D50A	06110275R0	60	
63A	BKN-b 1P+N D63A	06110276R0	60	



BKN-b 2P

10kA at 400VAC

In	Model	Catalog No.	Pack. unit (Pcs.)	PRICE
1A	BKN-b 2P D1A	06110277R0	60	
2A	BKN-b 2P D2A	06110278R0	60	
3A	BKN-b 2P D3A	06110279R0	60	
4A	BKN-b 2P D4A	06110280R0	60	
6A	BKN-b 2P D6A	06110281R0	60	
10A	BKN-b 2P D10A	06110282R0	60	
16A	BKN-b 2P D16A	06110283R0	60	
20A	BKN-b 2P D20A	06110284R0	60	
25A	BKN-b 2P D25A	06110285R0	60	
32A	BKN-b 2P D32A	06110286R0	60	
40A	BKN-b 2P D40A	06110287R0	60	
50A	BKN-b 2P D50A	06110288R0	60	
63A	BKN-b 2P D63A	06110289R0	60	

Miniature circuit breakers

DIN rail mounting



BKN-b type, D curve



BKN-b 3P



BKN-b 3P+N



BKN-b 4P

Catalog No.

10kA at 400VAC

In	Model	Catalog No.	Pack. unit (Pcs.)	PRICE
1A	BKN-b 3P D1A	06110290R0	40	
2A	BKN-b 3P D2A	06110291R0	40	
3A	BKN-b 3P D3A	06110292R0	40	
4A	BKN-b 3P D4A	06110293R0	40	
6A	BKN-b 3P D6A	06110294R0	40	
10A	BKN-b 3P D10A	06110295R0	40	
16A	BKN-b 3P D16A	06110296R0	40	
20A	BKN-b 3P D20A	06110297R0	40	
25A	BKN-b 3P D25A	06110298R0	40	
32A	BKN-b 3P D32A	06110299R0	40	
40A	BKN-b 3P D40A	06110300R0	40	
50A	BKN-b 3P D50A	06110301R0	40	
63A	BKN-b 3P D63A	06110302R0	40	

10kA at 400VAC

In	Model	Catalog No.	Pack. unit (Pcs.)	PRICE
1A	BKN-b 3P+N D1A	06110303R0	30	
2A	BKN-b 3P+N D2A	06110304R0	30	
3A	BKN-b 3P+N D3A	06110305R0	30	
4A	BKN-b 3P+N D4A	06110306R0	30	
6A	BKN-b 3P+N D6A	06110307R0	30	
10A	BKN-b 3P+N D10A	06110308R0	30	
16A	BKN-b 3P+N D16A	06110309R0	30	
20A	BKN-b 3P+N D20A	06110310R0	30	
25A	BKN-b 3P+N D25A	06110311R0	30	
32A	BKN-b 3P+N D32A	06110312R0	30	
40A	BKN-b 3P+N D40A	06110313R0	30	
50A	BKN-b 3P+N D50A	06110314R0	30	
63A	BKN-b 3P+N D63A	06110315R0	30	

10kA at 400VAC

In	Model	Catalog No.	Pack. unit (Pcs.)	PRICE
1A	BKN-b 4P D1A	06110316R0	30	
2A	BKN-b 4P D2A	06110317R0	30	
3A	BKN-b 4P D3A	06110318R0	30	
4A	BKN-b 4P D4A	06110319R0	30	
6A	BKN-b 4P D6A	06110320R0	30	
10A	BKN-b 4P D10A	06110321R0	30	
16A	BKN-b 4P D16A	06110322R0	30	
20A	BKN-b 4P D20A	06110323R0	30	
25A	BKN-b 4P D25A	06110324R0	30	
32A	BKN-b 4P D32A	06110325R0	30	
40A	BKN-b 4P D40A	06110326R0	30	
50A	BKN-b 4P D50A	06110327R0	30	
63A	BKN-b 4P D63A	06110328R0	30	

BKN-c type



BKN-c 2P

Certificate

CE

Technical data

Standard	Confirming to IEC60898	
Approval	CCC, SABS, SEMKO CB	
Protection	Against overload and short circuit	
Rated current In	1, 2, 3, 4, 6, 10, 16, 20, 25, 32, 40, 50, 63A	
Rated voltage	1pole 230/400VAC 50/60Hz 2, 3, 4pole 400VAC 50/60Hz	
Breaking capacity	6kA	
Characteristic	B, C, D curve	
Number of poles	1P, 1P+N, 2P, 3P, 3P+N and 4P	
Type of trip	Thermal-magnetic release	
Type of terminal	Dual type (Lug & Screw)	
Terminal capacity	Cables up to 25mm ²	
Installation	Mounting on 35mm DIN rail	
Width	17.8mm per pole	
Electrical endurance		
In	1 ... 32A	40 ... 63A
Endurance	6000 cycles	6000 cycles
Max. frequency (Cycles/hour)	240	120



Optional accessories ... Auxiliary switch, AX

Composition	Consists of 1 changeover contact	
Rating	AC circuit	DC circuit
	6A at 240VAC	2A at 48VDC
	3A at 415VAC	1A at 125VDC
Type of terminal	Dual type	
Terminal capacity	Cables up to 2.5mm ²	
Width	9mm	



Optional accessories ... Auxiliary switch, AL

Composition	Consists of 1 changeover contact	
Rating	AC circuit	DC circuit
	6A at 230VAC	2A at 48VDC
	3A at 415VAC	1A at 125VDC
Type of terminal	Dual type	
Terminal capacity	Cables up to 2.5mm ²	
Width	9mm	

Miniature circuit breakers

DIN rail mounting



High rupturing capacity

BKH type



BKH 1P

Technical data

Standard	Confirming to IEC60947-2
Approval	CCC, CQC CB †
Protection	Overload and short circuit
Rated current In	63, 80, 100, 125A
Rated voltage	1pole 230/400VAC 50/60Hz 2, 3, 4pole 400VAC 50/60Hz
Breaking capacity	10kA
Characteristic	C, D curve
Number of poles	1P, 2P, 3P, 3P+N, 4P
Type of trip	Thermal magnetic release
Type of terminal	Lug type
Terminal capacity	Cables up to 50mm ²
Installation	Mounting on 35mm DIN rail
Width	27mm per pole
Electrical endurance	6000 cycles

Catalog No.

C curve

Type	In	Model	Catalog No.	Pack. unit (Pcs.)	PRICE
1P	63A	BKH -C-63-1	06110329R0	72	
	80A	BKH -C-80-1	06110330R0	72	
	100A	BKH -C-100-1	06110331R0	72	
	125A	BKH -C-125-1	06110332R0	72	
2P	63A	BKH -C-63-2	06110337R0	36	
	80A	BKH -C-80-2	06110338R0	36	
	100A	BKH -C-100-2	06110339R0	36	
	125A	BKH -C-125-2	06110340R0	36	
3P	63A	BKH -C-63-3	06110345R0	24	
	80A	BKH -C-80-3	06110346R0	24	
	100A	BKH -C-100-3	06110347R0	24	
	125A	BKH -C-125-3	06110348R0	24	
3P+N	63A	BKH -C-63-3+N	06110353R0	18	
	80A	BKH -C-80-3+N	06110354R0	18	
	100A	BKH -C-100-3+N	06110355R0	18	
	125A	BKH -C-125-3+N	06110356R0	18	
4P	63A	BKH -C-63-4	06110361R0	18	
	80A	BKH -C-80-4	06110362R0	18	
	100A	BKH -C-100-4	06110363R0	18	
	125A	BKH -C-125-4	06110364R0	18	

D curve

Type	In	Model	Catalog No.	Pack. unit (Pcs.)	PRICE
1P	63A	BKH -D-63-1	06110333R0	72	
	80A	BKH -D-80-1	06110334R0	72	
	100A	BKH -D-100-1	06110335R0	72	
	125A	BKH -D-125-1	06110336R0	72	
2P	63A	BKH -D-63-2	06110341R0	36	
	80A	BKH -D-80-2	06110342R0	36	
	100A	BKH -D-100-2	06110343R0	36	
	125A	BKH -D-125-2	06110344R0	36	
3P	63A	BKH -D-63-3	06110349R0	24	
	80A	BKH -D-80-3	06110350R0	24	
	100A	BKH -D-100-3	06110351R0	24	
	125A	BKH -D-125-3	06110352R0	24	
3P+N	63A	BKH -D-63-3+N	06110357R0	18	
	80A	BKH -D-80-3+N	06110358R0	18	
	100A	BKH -D-100-3+N	06110359R0	18	
	125A	BKH -D-125-3+N	06110360R0	18	
4P	63A	BKH -D-63-4	06110365R0	18	
	80A	BKH -D-80-4	06110366R0	18	
	100A	BKH -D-100-4	06110367R0	18	
	125A	BKH -D-125-4	06110368R0	18	

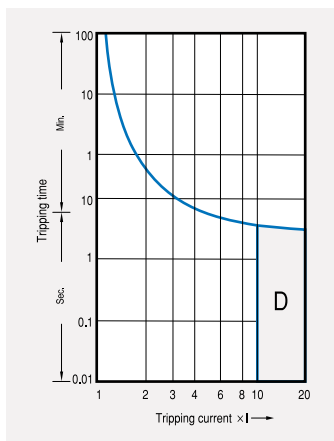
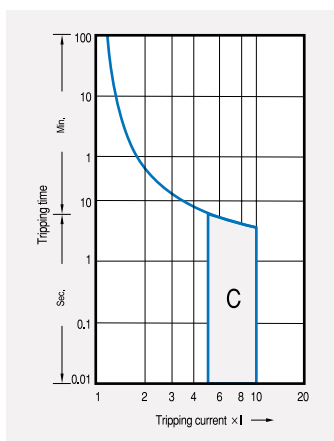

DIN rail mounting

BFN type



BFN

Technical data

Standard	IEC 60947-2
Approval	SEMKO
Protection	Overload and short circuit
Rated current	5, 10, 15, 20, 30, 40, 50A
Rated voltage	1pole 10kA at 230VAC 2, 3pole 10kA at 400VAC
Breaking capacity	10kA
Number of poles	1, 2, 3pole
Type of trip	Thermal magnetic release
Type of terminal	Lug type (14-6 AWG.)
Installation	Plug-in
Width	60mm
Slot	56mm
Accessory	Not available

Catalog No.

BFN 10kA at 230/400VAC



1pole				
In	Model	Catalog No.	Pack. unit (Pcs.)	PRICE
5A	BFN51 5A	06110704R0	120	
10A	BFN51 10A	06110705R0	120	
15A	BFN51 15A	06110706R0	120	
20A	BFN51 20A	06110707R0	120	
30A	BFN51 30A	06110708R0	120	
40A	BFN51 40A	06110709R0	120	
50A	BFN51 50A	06110711R0	120	
Weight/pc		0.14kg		

2pole				
In	Model	Catalog No.	Pack. unit (Pcs.)	PRICE
5A	BFN52 5A	06120681R0	60	
10A	BFN52 10A	06120682R0	60	
15A	BFN52 15A	06120683R0	60	
20A	BFN52 20A	06120684R0	60	
30A	BFN52 30A	06120685R0	60	
40A	BFN52 40A	06120686R0	60	
50A	BFN52 50A	06120687R0	60	
Weight/pc		0.29kg		

3pole				
In	Model	Catalog No.	Pack. unit (Pcs.)	PRICE
5A	BFN53 5A	06130239R0	40	
10A	BFN53 10A	06130240R0	40	
15A	BFN53 15A	06130241R0	40	
20A	BFN53 20A	06130242R0	40	
30A	BFN53 30A	06130243R0	40	
40A	BFN53 40A	06130244R0	40	
50A	BFN53 50A	06130245R0	40	
Weight/pc		0.43kg		

Residual current circuit breakers with overcurrent protection

DIN rail mounting

RKP type



RKP 1P+N

Certificate
CE

Technical data

Protection	Ground fault and overcurrent
Rated current, I_n	3(B, C, D), 6, 10, 16, 20, 25, 32A (B, C, D curve)
Rated residual current	
Operating, $I_{\Delta n}$	15, 30, 100, 300mA (non-adjustable)
Non-operating, $I_{\Delta no}$	$0.5I_{\Delta n}$
Number of poles	1P+N
Rated voltage	230VAC
Residual current off-time	≤ 0.1 sec.
Standard	IEC 61009
Approval	CCC, CQC CB, CE
Type of trip	
Ground fault	Electronic
Overcurrent	Thermal-magnetic
Breaking capacity	4.5kA
Electrical endurance	20000 operations
Mount	On 35mm DIN rail
Width	9mm per pole
Terminal	Lug type (cable up to 10mm ²)

Catalog No.

RKP B curve

I_n	$I_{\Delta n}$	Model	Catalog No.	Pack. unit (Pcs.)
3A	30mA	Not applicable	Not applicable	Not applicable
	100mA	Not applicable	Not applicable	Not applicable
	300mA	Not applicable	Not applicable	Not applicable
6A	30mA	RKP-B6-1+N/30mA	06220123R0	60
	100mA	RKP-B6-1+N/100mA	06220124R0	60
	300mA	RKP-B6-1+N/300mA	06220125R0	60
10A	30mA	RKP-B10-1+N/30mA	06220127R0	60
	100mA	RKP-B10-1+N/100mA	06220128R0	60
	300mA	RKP-B10-1+N/300mA	06220129R0	60
16A	30mA	RKP-B16-1+N/30mA	06220131R0	60
	100mA	RKP-B16-1+N/100mA	06220132R0	60
	300mA	RKP-B16-1+N/300mA	06220133R0	60
20A	30mA	RKP-B20-1+N/30mA	06220135R0	60
	100mA	RKP-B20-1+N/100mA	06220136R0	60
	300mA	RKP-B20-1+N/300mA	06220137R0	60
25A	30mA	RKP-B25-1+N/30mA	06220139R0	60
	100mA	RKP-B25-1+N/100mA	06220140R0	60
	300mA	RKP-B25-1+N/300mA	06220141R0	60
32A	30mA	RKP-B32-1+N/30mA	06220143R0	60
	100mA	RKP-B32-1+N/100mA	06220144R0	60
	300mA	RKP-B32-1+N/300mA	06220145R0	60



RKP 1P+N

Certificate
CE

Catalog No.

RKP C curve

In	I _{Δn}	Model	Catalog No.	Pack. unit (Pcs.)
3A	30mA	RKP-C3-1+N/30mA	06220147R0	60
	100mA	RKP-C3-1+N/100mA	06220148R0	60
	300mA	RKP-C3-1+N/300mA	06220149R0	60
6A	30mA	RKP-C6-1+N/30mA	06220151R0	60
	100mA	RKP-C6-1+N/100mA	06220152R0	60
	300mA	RKP-C6-1+N/300mA	06220153R0	60
10A	30mA	RKP-C10-1+N/30mA	06220155R0	60
	100mA	RKP-C10-1+N/100mA	06220156R0	60
	300mA	RKP-C10-1+N/300mA	06220157R0	60
16A	30mA	RKP-C16-1+N/30mA	06220159R0	60
	100mA	RKP-C16-1+N/100mA	06220160R0	60
	300mA	RKP-C16-1+N/300mA	06220161R0	60
20A	30mA	RKP-C20-1+N/30mA	06220163R0	60
	100mA	RKP-C20-1+N/100mA	06220164R0	60
	300mA	RKP-C20-1+N/300mA	06220165R0	60
25A	30mA	RKP-C25-1+N/30mA	06220167R0	60
	100mA	RKP-C25-1+N/100mA	06220168R0	60
	300mA	RKP-C25-1+N/300mA	06220169R0	60
32A	30mA	RKP-C32-1+N/30mA	06220171R0	60
	100mA	RKP-C32-1+N/100mA	06220172R0	60
	300mA	RKP-C32-1+N/300mA	06220173R0	60

RKP D curve



In	I _{Δn}	Model	Catalog No.	Pack. unit (Pcs.)
3A	30mA	RKP-D3-1+N/30mA	06220175R0	60
	100mA	RKP-D3-1+N/100mA	06220176R0	60
	300mA	RKP-D3-1+N/300mA	06220177R0	60
6A	30mA	RKP-D6-1+N/30mA	06220179R0	60
	100mA	RKP-D6-1+N/100mA	06220180R0	60
	300mA	RKP-D6-1+N/300mA	06220181R0	60
10A	30mA	RKP-D10-1+N/30mA	06220183R0	60
	100mA	RKP-D10-1+N/100mA	06220184R0	60
	300mA	RKP-D10-1+N/300mA	06220185R0	60
16A	30mA	RKP-D16-1+N/30mA	06220187R0	60
	100mA	RKP-D16-1+N/100mA	06220188R0	60
	300mA	RKP-D16-1+N/300mA	06220189R0	60
20A	30mA	RKP-D20-1+N/30mA	06220191R0	60
	100mA	RKP-D20-1+N/100mA	06220192R0	60
	300mA	RKP-D20-1+N/300mA	06220193R0	60
25A	30mA	RKP-D25-1+N/30mA	06220195R0	60
	100mA	RKP-D25-1+N/100mA	06220196R0	60
	300mA	RKP-D25-1+N/300mA	06220197R0	60
32A	30mA	RKP-D32-1+N/30mA	06220199R0	60
	100mA	RKP-D32-1+N/100mA	06220200R0	60
	300mA	RKP-D32-1+N/300mA	06220201R0	60

Residual current circuit breakers with overcurrent protection

DIN rail mounting

RKS type



RKS 1+N

Certificate
CE

Technical data

Standard	Confirming to IEC 61009
Protection	Ground fault and overcurrent
Rated current I_n	6, 10, 16, 20, 25, 32A
Rated voltage	230VAC
Breaking capacity	10kA
Characteristic	B, C Curve
Rated residual operating current (mA)	30,100
Number of poles	1P+N
Type of trip	Electronic (Ground fault) Thermal-magnetic (Overcurrent)
Type of terminal	Lug type
Terminal capacity	Cables up to 10mm ²
Installation	35mm DIN rail
Width	18mm
Electrical endurance	4,000cycles
In	
Endurance	
Max. frequency (Cycles/hour)	

Catalog No.

RKS B Curve

I_n	$I_{\Delta n}$	Model	Catalog No.	Pack. unit (Pcs.)
6A	30mA	RKS -B6-1+N/30mA	06220395R0	50
	100mA	RKS -B6-1+N/100mA	06220396R0	50
10A	30mA	RKS -B10-1+N/30mA	06220397R0	50
	100mA	RKS -B10-1+N/100mA	06220398R0	50
16A	30mA	RKS -B16-1+N/30mA	06220399R0	50
	100mA	RKS -B16-1+N/100mA	06220400R0	50
20A	30mA	RKS -B20-1+N/30mA	06220401R0	50
	100mA	RKS -B20-1+N/100mA	06220402R0	50
25A	30mA	RKS -B25-1+N/30mA	06220403R0	50
	100mA	RKS -B25-1+N/100mA	06220404R0	50
32A	30mA	RKS -B32-1+N/30mA	06220405R0	50
	100mA	RKS -B32-1+N/100mA	06220406R0	50

RKS C Curve

I_n	$I_{\Delta n}$	Model	Catalog No.	Pack. unit (Pcs.)
6A	30mA	RKS -C6-1+N/30mA	06220407R0	50
	100mA	RKS -C6-1+N/100mA	06220408R0	50
10A	30mA	RKS -C10-1+N/30mA	06220409R0	50
	100mA	RKS -C10-1+N/100mA	06220410R0	50
16A	30mA	RKS -C16-1+N/30mA	06220411R0	50
	100mA	RKS -C16-1+N/100mA	06220412R0	50
20A	30mA	RKS -C20-1+N/30mA	06220413R0	50
	100mA	RKS -C20-1+N/100mA	06220414R0	50
25A	30mA	RKS -C25-1+N/30mA	06220415R0	50
	100mA	RKS -C25-1+N/100mA	06220416R0	50
32A	30mA	RKS -C32-1+N/30mA	06220417R0	50
	100mA	RKS -C32-1+N/100mA	06220418R0	50

DIN rail mounting

RKS-b type



RKS-b 1+N

Certificate
CE

Technical data

Standard	Confirming to IEC 61009
Protection	Ground fault and overcurrent
Rated current I_n	6, 10, 16, 20, 25, 32, 40, 50A
Rated voltage	230VAC
Breaking capacity	10kA
Characteristic	B, C Curve
Rated residual operating current(mA)	30,100
Number of poles	1P+N
Type of trip	Electronic (Ground fault) Thermal-magnetic (Overcurrent)
Type of terminal	Lug type
Terminal capacity	Cables up to 10mm ²
Installation	35mm DIN rail
Width	18mm
Electrical endurance	4,000cycles
In	
Endurance	
Max. frequency	
(Cycles/hour)	

Catalog No.

RKS B Curve

In	I _{Δn}	Model	Catalog No.	Pack. unit (Pcs.)
6A	30mA	RKS-b 1P+N B6 30mA	06220615R0	50
	100mA	RKS-b 1P+N B6 100mA	06220616R0	50
10A	30mA	RKS-b 1P+N B10 30mA	06220617R0	50
	100mA	RKS-b 1P+N B10 100m	06220618R0	50
16A	30mA	RKS-b 1P+N B16 30mA	06220619R0	50
	100mA	RKS-b 1P+N B16 100mA	06220620R0	50
20A	30mA	RKS-b 1P+N B20 30mA	06220621R0	50
	100mA	RKS-b 1P+N B20 100mA	06220622R0	50
25A	30mA	RKS-b 1P+N B25 30mA	06220623R0	50
	100mA	RKS-b 1P+N B25 100mA	06220624R0	50
32A	30mA	RKS-b 1P+N B32 30mA	06220625R0	50
	100mA	RKS-b 1P+N B32 100mA	06220626R0	50
40A	30mA	RKS-b 1P+N B40 30mA	06220627R0	50
	100mA	RKS-b 1P+N B40 100mA	06220628R0	50
50A	30mA	RKS-b 1P+N B50 30mA	06220629R0	50
	100mA	RKS-b 1P+N B50 100mA	06220630R0	50

RKS C Curve

In	I _{Δn}	Model	Catalog No.	Pack. unit (Pcs.)
6A	30mA	RKS-b 1P+N C6 30mA	06220647R0	50
	100mA	RKS-b 1P+N C6 100mA	06220648R0	50
10A	30mA	RKS-b 1P+N C10 30mA	06220649R0	50
	100mA	RKS-b 1P+N C10 100mA	06220650R0	50
16A	30mA	RKS-b 1P+N C16 30mA	06220651R0	50
	100mA	RKS-b 1P+N C16 100mA	06220652R0	50
20A	30mA	RKS-b 1P+N C20 30mA	06220653R0	50
	100mA	RKS-b 1P+N C20 100mA	06220654R0	50
25A	30mA	RKS-b 1P+N C25 30mA	06220655R0	50
	100mA	RKS-b 1P+N C25 100mA	06220656R0	50
32A	30mA	RKS-b 1P+N C32 30mA	06220657R0	50
	100mA	RKS-b 1P+N C32 100mA	06220658R0	50
40A	30mA	RKS-b 1P+N C40 30mA	06220659R0	50
	100mA	RKS-b 1P+N C40 100mA	06220660R0	50
50A	30mA	RKS-b 1P+N C50 30mA	06220661R0	50
	100mA	RKS-b 1P+N C50 100mA	06220662R0	50

Residual current circuit breakers with overcurrent protection

DIN rail & Screw type

KGR type



32KGRc/d

Certificate

CE

Technical data

Type	32KGRc	32KGRd
Protection	Ground fault and overcurrent	
Rated current, I _n	15, 20, 30A	
Rated residual current		
Operating, I _{Δn}	15, 30mA (non-adjustable)	
Non-operating, I _{Δno}	0.5I _{Δn}	
Number of poles	2pole	
Rated voltage	110/220VAC	
Residual current off-time	≤ 0.03 sec.	
Standard	KS	
Approval	KERI, CE	
Type of trip		
Ground fault	Electronic	
Overcurrent	Bimetallic	
Breaking capacity	1.5kA	2.5kA
Electrical endurance	6000 operations	
Mount	On 35mm DIN rail	
Width	35mm	
Terminal	Screw clamp type (cable up to 25mm ²)	

Catalog No.

32KGRc Type

In	I _{Δn}	Model	Catalog No.	Pack. unit (Pcs.)
15A	15mA	32KGRc 15A 15mA 0.03S	0750000400	60
	30mA	32KGRc 15A 30mA 0.03S	0750000100	60
20A	15mA	32KGRc 20A 15mA 0.03S	0750000500	60
	30mA	32KGRc 20A 30mA 0.03S	0750000200	60
30A	15mA	32KGRc 30A 15mA 0.03S	0750000600	60
	30mA	32KGRc 30A 30mA 0.03S	0750000300	60

32KGRd Type

In	I _{Δn}	Model	Catalog No.	Pack. unit (Pcs.)
15A	15mA	32KGRd 15A 15mA 0.03S	0748001000	60
	30mA	32KGRd 15A 30mA 0.03S	0748001100	60
20A	15mA	32KGRd 20A 15mA 0.03S	0748001200	60
	30mA	32KGRd 20A 30mA 0.03S	0748001300	60
30A	15mA	32KGRd 30A 15mA 0.03S	0748001400	60
	30mA	32KGRd 30A 30mA 0.03S	0748001500	60

Residual current circuit breakers

DIN rail & Screw type

CE

GRh type



32GRhc/d

Certificate

CE

Technical data

Type	32GRhc	32GRhd
Protection	Ground fault and overcurrent	
Rated current, I _n	15, 20, 30A	
Rated residual current		
Operating, I _{Δn}	15, 30mA (non-adjustable)	
Non-operating, I _{Δno}	0.5I _{Δn}	
Number of poles	2pole	
Rated voltage	110/220VAC	
Residual current off-time	≤ 0.03 sec.	
Standard	KS	
Approval	KERI, CE	
Type of trip		
Ground fault	Electronic	
Overcurrent	Bimetallic	
Breaking capacity	1.5kA	2.5kA
Electrical endurance	6000 operations	
Mount	On 35mm DIN rail	
Width	35mm	
Terminal	Screw clamp type (cable up to 25mm ²)	

Residual current circuit breakers with overcurrent protection

DIN rail & Screw type

BS type



BS32c/d

Certificate

CE

Technical data

Type	BS32c	BS32d
Protection	Ground fault and overcurrent	
Rated current, I _n	6, 10, 15, 20, 30A	10, 15, 20, 30A
Rated residual current		
Operating, I _{Δn}	15, 30mA (non-adjustable)	
Non-operating, I _{Δno}	0.5I _{Δn}	
Number of poles	2pole	
Rated voltage	110/220VAC	
Residual current off-time	≤ 0.03 sec.	
Standard	KS	
Approval	KERI, CE	
Type of trip		
Ground fault	Electronic	
Overcurrent	Bimetallic	
Breaking capacity	1.5kA	2.5kA
Electrical endurance	6000 operations	
Mount	On 35mm DIN rail	
Width	35mm	
Terminal	Screw clamp type (cable up to 25mm ²)	

Residual current circuit breakers

DIN rail mounting



RKN type



Certificate
CE

Technical data

Standard	Confirming to IEC61008	
Protection	Ground fault	
Rated current, I_n	25, 32, 40, 63A	
Number of poles	2(1+N), 4(3+N)pole	
Rated sensitivity currents, $I_{\Delta n}$	30, 100, 300mA	
Rated residual non-operating current	$0.5 \times I_{\Delta n}$	
Rated voltages	2pole	240VAC
	4pole	240/415VAC
Residual current off-time at $I_{\Delta n}$	$\leq 0.1s$	
Rated making capacity, I_m	500A for $I_n=25, 32, 40A$	
	630A for $I_n=63A$	
Rated conditional short-circuit current, I_{nc}	6kA for $I_n=25, 32, 40, 63A$	
Type of trip	Electro-magnetic	
Type of terminal	Lug type	
Terminal capacity	Cables up to 35mm ²	
Installation	35mm DIN rail	
Type of operation	A/AC	
Slot size	45mm	

Catalog No.

Pole	I_n	$I_{\Delta n}$	Model	Catalog No.	Pack.unit (Pcs.)
2P	25A	30mA	RKN -25-2/30mA	06220103R0	60
			RKN -32-2/30mA	06220106R0	60
			RKN -40-2/30mA	06220109R0	60
			RKN -63-2/30mA	06220112R0	60
	32A	100mA	RKN -25-2/100mA	06220104R0	60
			RKN -32-2/100mA	06220107R0	60
			RKN -40-2/100mA	06220110R0	60
			RKN -63-2/100mA	06220113R0	60
	40A	300mA	RKN -25-2/300mA	06220105R0	60
			RKN -32-2/300mA	06220108R0	60
			RKN -40-2/300mA	06220111R0	60
			RKN -63-2/300mA	06220114R0	60

Pole	I_n	$I_{\Delta n}$	Model	Catalog No.	Pack.unit (Pcs.)
4P	25A	30mA	RKN -25-4/30mA	06240013R0	30
			RKN -32-4/30mA	06240016R0	30
			RKN -40-4/30mA	06240019R0	30
			RKN -63-4/30mA	06240022R0	30
	32A	100mA	RKN -25-4/100mA	06240014R0	30
			RKN -32-4/100mA	06240017R0	30
			RKN -40-4/100mA	06240020R0	30
			RKN -63-4/100mA	06240023R0	30
	40A	300mA	RKN -25-4/300mA	06240015R0	30
			RKN -32-4/300mA	06240018R0	30
			RKN -40-4/300mA	06240021R0	30
			RKN -63-4/300mA	06240024R0	30

Residual current circuit breakers

DIN rail mounting



RKN type

Catalog No.

A type

Pole	In	I _{Δn}	Model	Catalog No.	Pack.unit (Pcs.)
2P	25A	30mA	RKN 2P 25A 30mA A type	06220444R0	60
	32A		RKN 2P 32A 30mA A type	06220447R0	60
	40A		RKN 2P 40A 30mA A type	06220450R0	60
	63A		RKN 2P 63A 30mA A type	06220453R0	60
2P	25A	100mA	RKN 2P 25A 100mA A type	06220445R0	60
	32A		RKN 2P 32A 100mA A type	06220448R0	60
	40A		RKN 2P 40A 100mA A type	06220451R0	60
	63A		RKN 2P 63A 100mA A type	06220454R0	60
2P	25A	300mA	RKN 2P 25A 300mA A type	06220446R0	60
	32A		RKN 2P 32A 300mA A type	06220449R0	60
	40A		RKN 2P 40A 300mA A type	06220452R0	60
	63A		RKN 2P 63A 300mA A type	06220455R0	60

Pole	In	I _{Δn}	Model	Catalog No.	Pack.unit (Pcs.)
4P	25A	30mA	RKN 4P 25A 30mA A type	06220456R0	30
	32A		RKN 4P 32A 30mA A type	06220459R0	30
	40A		RKN 4P 40A 30mA A type	06220462R0	30
	63A		RKN 4P 63A 30mA A type	06220465R0	30
4P	25A	100mA	RKN 4P 25A 100mA A type	06220457R0	30
	32A		RKN 4P 32A 100mA A type	06220460R0	30
	40A		RKN 4P 40A 100mA A type	06220463R0	30
	63A		RKN 4P 63A 100mA A type	06220466R0	30
4P	25A	300mA	RKN 4P 25A 300mA A type	06220458R0	30
	32A		RKN 4P 32A 300mA A type	06220461R0	30
	40A		RKN 4P 40A 300mA A type	06220464R0	30
	63A		RKN 4P 63A 300mA A type	06220467R0	30

RKN-b type



Certificate
CE

Technical data

Standard	Confirming to IEC61008	
Protection	Ground fault	
Rated current, I_n	25, 32, 40, 63, 100A	
Number of poles	2(1+N), 4(3+N)pole	
Rated sensitivity currents, $I_{\Delta n}$	30, 100, 300mA	
Rated residual non-operating current	$0.5 \times I_{\Delta n}$	
Rated voltages	2pole	240VAC
	4pole	240/415VAC
Residual current off-time at $I_{\Delta n}$	$\leq 0.1s$	
Rated making capacity, I_m	500A for $I_n=25, 32, 40A$	
	630A for $I_n=63A$	
Rated conditional short-circuit current, I_{nc}	6kA for $I_n=25, 32, 40, 63A$	
Type of trip	Electro-magnetic	
Type of terminal	Lug type	
Terminal capacity	Cables up to 35mm ²	
Installation	35mm DIN rail	
Type of operation	A/AC	
Slot size	45mm	

Catalog No.

Pole	I_n	$I_{\Delta n}$	Model	Catalog No.	Pack.unit (Pcs.)
2P	25A	30mA	RKN-b 1P+N 25A 30mA	06220663R0	60
	32A		RKN-b 1P+N 32A 30mA	06220666R0	60
	40A		RKN-b 1P+N 40A 30mA	06220669R0	60
	63A		RKN-b 1P+N 63A 30mA	06220672R0	60
	80A		RKN-b 1P+N 80A 30mA	06220678R0	60
	100A		RKN-b 1P+N 100A 30mA	06220681R0	60
	25A	100mA	RKN-b 1P+N 25A 100mA	06220664R0	60
	32A		RKN-b 1P+N 32A 100mA	06220667R0	60
	40A		RKN-b 1P+N 40A 100mA	06220670R0	60
	63A		RKN-b 1P+N 63A 100mA	06220673R0	60
	80A		RKN-b 1P+N 80A 100mA	06220679R0	60
	100A		RKN-b 1P+N 100A 100mA	06220682R0	60
	25A	300mA	RKN-b 1P+N 25A 300mA	06220665R0	60
	32A		RKN-b 1P+N 32A 300mA	06220668R0	60
	40A		RKN-b 1P+N 40A 300mA	06220671R0	60
	63A		RKN-b 1P+N 63A 300mA	06220674R0	60
	80A		RKN-b 1P+N 80A 300mA	06220680R0	60
	100A		RKN-b 1P+N 100A 300mA	06220683R0	60

Residual current circuit breakers

DIN rail mounting



RKN-b type

Catalog No.

Pole	In	I _{Δn}	Model	Catalog No.	Pack.unit (Pcs.)
4P	25A	30mA	RKN-b 3P+N 25A 100mA	06240095R0	30
			RKN-b 3P+N 32A 100mA	06240098R0	30
			RKN-b 3P+N 40A 100mA	06240101R0	30
			RKN-b 3P+N 63A 100mA	06240104R0	30
			RKN-b 3P+N 80A 100mA	06240110R0	30
			RKN-b 3P+N 100A 100mA	06240113R0	30
	25A	100mA	RKN-b 3P+N 25A 300mA	06240096R0	30
			RKN-b 3P+N 32A 300mA	06240099R0	30
			RKN-b 3P+N 40A 300mA	06240102R0	30
			RKN-b 3P+N 63A 300mA	06240105R0	30
			RKN-b 3P+N 80A 300mA	06240111R0	30
			RKN-b 3P+N 100A 300mA	06240114R0	30
	25A	300mA	RKN-b 3P+N 25A 300mA	06240096R0	30
			RKN-b 3P+N 32A 300mA	06240099R0	30
			RKN-b 3P+N 40A 300mA	06240102R0	30
			RKN-b 3P+N 63A 300mA	06240105R0	30
RKN-b 3P+N 80A 300mA			06240111R0	30	
RKN-b 3P+N 100A 300mA			06240114R0	30	

A type

Pole	In	I _{Δn}	Model	Catalog No.	Pack.unit (Pcs.)
2P	25A	30mA	RKN-b 1P+N 25A 30mA A type	06220749R0	60
			RKN-b 1P+N 32A 30mA A type	06220752R0	60
			RKN-b 1P+N 40A 30mA A type	06220755R0	60
			RKN-b 1P+N 63A 30mA A type	06220758R0	60
	25A	100mA	RKN-b 1P+N 25A 100mA A type	06220750R0	60
			RKN-b 1P+N 32A 100mA A type	06220753R0	60
			RKN-b 1P+N 40A 100mA A type	06220756R0	60
			RKN-b 1P+N 63A 100mA A type	06220759R0	60
	25A	300mA	RKN-b 1P+N 25A 300mA A type	06220751R0	60
			RKN-b 1P+N 32A 300mA A type	06220754R0	60
			RKN-b 1P+N 40A 300mA A type	06220757R0	60
			RKN-b 1P+N 63A 300mA A type	06220760R0	60

Pole	In	I _{Δn}	Model	Catalog No.	Pack.unit (Pcs.)
4P	25A	30mA	RKN-b 3P+N 25A 30mA A type	06240148R0	30
			RKN-b 3P+N 32A 30mA A type	06240151R0	30
			RKN-b 3P+N 40A 30mA A type	06240154R0	30
			RKN-b 3P+N 63A 30mA A type	06240157R0	30
	25A	100mA	RKN-b 3P+N 25A 100mA A type	06240149R0	30
			RKN-b 3P+N 32A 100mA A type	06240152R0	30
			RKN-b 1P+N 40A 100mA A type	06240155R0	30
			RKN-b 3P+N 63A 100mA A type	06240158R0	30
	25A	300mA	RKN-b 3P+N 25A 300mA A type	06240150R0	30
			RKN-b 3P+N 32A 300mA A type	06240153R0	30
			RKN-b 3P+N 40A 300mA A type	06240156R0	30
			RKN-b 3P+N 63A 300mA A type	06240159R0	30

Isolator, BKD type



Certificate
CE

Technical data

Number of poles	1, 2, 3, 4pole	
Standard	IEC60947-3	
Rated currents	40, 50, 63, 80, 100, 125A	
Rated voltages	240/415VAC	
Electrical endurance	40, 50, 63A	20000 cycles
	80, 100, 125A	10000 cycles
Type of terminal	Lug type	
Terminal capacity	Cables up to 50mm ²	
Installation	Mounting on 35mm DIN rail	
Width	17.5mm per pole	

Catalog No.

Pole	In	Model	Catalog No.	Pack. unit (Pcs.)
1P	40A	BKD-40-1	06110112R0	120
	50A	BKD-50-1	06110113R0	120
	63A	BKD-63-1	06110083R0	120
	80A	BKD-80-1	06110084R0	120
	100A	BKD-100-1	06110085R0	120
	125A	BKD-125-1	06110114R0	120

Pole	In	Model	Catalog No.	Pack. unit (Pcs.)
2P	40A	BKD-40-2	06120304R0	60
	50A	BKD-50-2	06120305R0	60
	63A	BKD-63-2	06120247R0	60
	80A	BKD-80-2	06120248R0	60
	100A	BKD-100-2	06120249R0	60
	125A	BKD-125-2	06120306R0	60

Pole	In	Model	Catalog No.	Pack. unit (Pcs.)
3P	40A	BKD-40-3	06130092R0	40
	50A	BKD-50-3	06130093R0	40
	63A	BKD-63-3	06130063R0	40
	80A	BKD-80-3	06130064R0	40
	100A	BKD-100-3	06130065R0	40
	125A	BKD-125-3	06130094R0	40

Pole	In	Model	Catalog No.	Pack. unit (Pcs.)
4P	40A	BKD-40-4	06140185R0	30
	50A	BKD-50-4	06140186R0	30
	63A	BKD-63-4	06140130R0	30
	80A	BKD-80-4	06140131R0	30
	100A	BKD-100-4	06140132R0	30
	125A	BKD-125-4	06140187R0	30

Residential breakers

60mm depth miniature circuit breakers

BF type



BF-a, BF-c

Description

- Trip unit with a fixed thermal and fixed magnetic trip
- All operating mechanisms are of the quick-make, quick-break type and are "trip free"
- Two and three-pole breakers shall have common tripping of allpoles.
- Operating handle is "Trip to Off"
- Operating hand and face plate shall indicate rated ampacity.
- Thermal elements shall be calibrated to operate in a 40°C ambient environment in standard.
- Electrical durability: 10, 000 operations at In
- Reference temperature: 40°C
- Connection by clamp terminal
- Offering the same slot and depth size with the GB type MCCBs.
 - 60mm depth
 - 50mm slot

Technical data

Type		BF-a	BF-c
Rated current		10~100A	10~100A
Breaking capacity, Icu	240V	10kA	5kA
	415V	2.5kA (2, 3pole)	2.5kA (2, 3pole)
Rated insulation voltage		460VAC	
Number of poles		1, 2, 3pole	
Standard		IEC 60947-2	
Protection		Overload and short circuit	
Characteristic		See operating curves (p. 44)	
Type of trip		Thermal magnetic release	
Type of terminal		Clamp type	
Installation		Holder mounting (Bolt on with fixing brackets)	
Width		25mm per pole	
Slot		50mm	
Accessory		Not available	

BF type

Catalog No.

BF-a		10kA at 240VAC / 2.5kA at 415VAC										
1Pole				2Poles				3Pole				
In	Model	Catalog No.	Pack. unit PRICE (Pcs.)	Model	Catalog No.	Pack. unit PRICE (Pcs.)	Model	Catalog No.	Pack. unit PRICE (Pcs.)	Model	Catalog No.	Pack. unit PRICE (Pcs.)
	10A	BF51a 10A	0607005100	60	BF52a 10A	0607006500	30	BF53a 10A	0607007900	20		
	15A	BF51a 15A	0607005200	60	BF52a 15A	0607006600	30	BF53a 15A	0607008000	20		
	20A	BF51a 20A	0607005300	60	BF52a 20A	0607006700	30	BF53a 20A	0607008100	20		
	30A	BF51a 30A	0607005400	60	BF52a 30A	0607006800	30	BF53a 30A	0607008200	20		
	40A	BF51a 40A	0607005500	60	BF52a 40A	0607006900	30	BF53a 40A	0607008300	20		
	50A	BF51a 50A	0607005600	60	BF52a 50A	0607007000	30	BF53a 50A	0607008400	20		
	60A	BF101a 60A	0608002100	60	BF102a 60A	0608002700	30	BF103a 60A	0608003300	20		
	75A	BF101a 75A	0608002200	60	BF102a 75A	0608002800	30	BF103a 75A	0608003400	20		
	100A	BF101a 100A	0608002300	60	BF102a 100A	0608002900	30	BF103a 100A	0608003500	20		
	Weight/pc		0.11kg			0.23kg			0.35kg			



BF-c		For 5kA at 240VAC / 2.5kA at 415VAC										
1Pole				2Poles				3Pole				
In	Model	Catalog No.	Pack. unit PRICE (Pcs.)	Model	Catalog No.	Pack. unit PRICE (Pcs.)	Model	Catalog No.	Pack. unit PRICE (Pcs.)	Model	Catalog No.	Pack. unit PRICE (Pcs.)
	10A	BF51c 10A	0607005800	60	BF52c 10A	0607007200	30	BF53c 10A	0607008600	20		
	15A	BF51c 15A	0607005900	60	BF52c 15A	0607007300	30	BF53c 15A	0607008700	20		
	20A	BF51c 20A	0607006000	60	BF52c 20A	0607007400	30	BF53c 20A	0607008800	20		
	30A	BF51c 30A	0607006100	60	BF52c 30A	0607007500	30	BF53c 30A	0607008900	20		
	40A	BF51c 40A	0607006200	60	BF52c 40A	0607007600	30	BF53c 40A	0607009000	20		
	50A	BF51c 50A	0607006300	60	BF52c 50A	0607007700	30	BF53c 50A	0607009100	20		
	60A	BF101c 60A	0608002400	60	BF102c 60A	0608003000	30	BF103c 60A	0608003600	20		
	75A	BF101c 75A	0608002500	60	BF102c 75A	0608003100	30	BF103c 75A	0608003700	20		
	100A	BF101c 100A	0608002600	60	BF102c 100A	0608003200	30	BF103c 100A	0608003800	20		
	Weight/pc		0.11kg			0.23kg			0.35kg			



Standard busbars



Description

- Applicable to the 18mm wide module devices
- Rated Voltage: 415VAC
- Current rating: 63A
- Standard length: 1m

<p>Type BB101</p>	<p>For single pole device</p>
<p>Type BB102</p>	
<p>Type BB201</p>	<p>For 2-pole device</p>
<p>Type BB202</p>	
<p>Type BB301</p>	<p>For 3-pole device</p>
<p>Type BB302</p>	
<p>Type BB401</p>	<p>For 4-pole device</p>
<p>Type BB402</p>	

Model	Catalog No.
Busbar, Type BB101, BKN 1P	70211413001
Busbar, Type BB102, BKM 1P	70211413002
Busbar, Type BB201, BKN 2P	70211413003
Busbar, Type BB202, BKM 2P	70211413004
Busbar, Type BB301, BKN 3P	70211413005
Busbar, Type BB302, BKM 3P	70211413006
Busbar, Type BB401, BKN 4P	70211413007
Busbar, Type BB102, BKM 4P	70211413008

Operating curves & temperature compensation

- BKN
- BKN-b
- BKN-c
- BKH
- BKP
- RKP
- RKS
- RKS-b

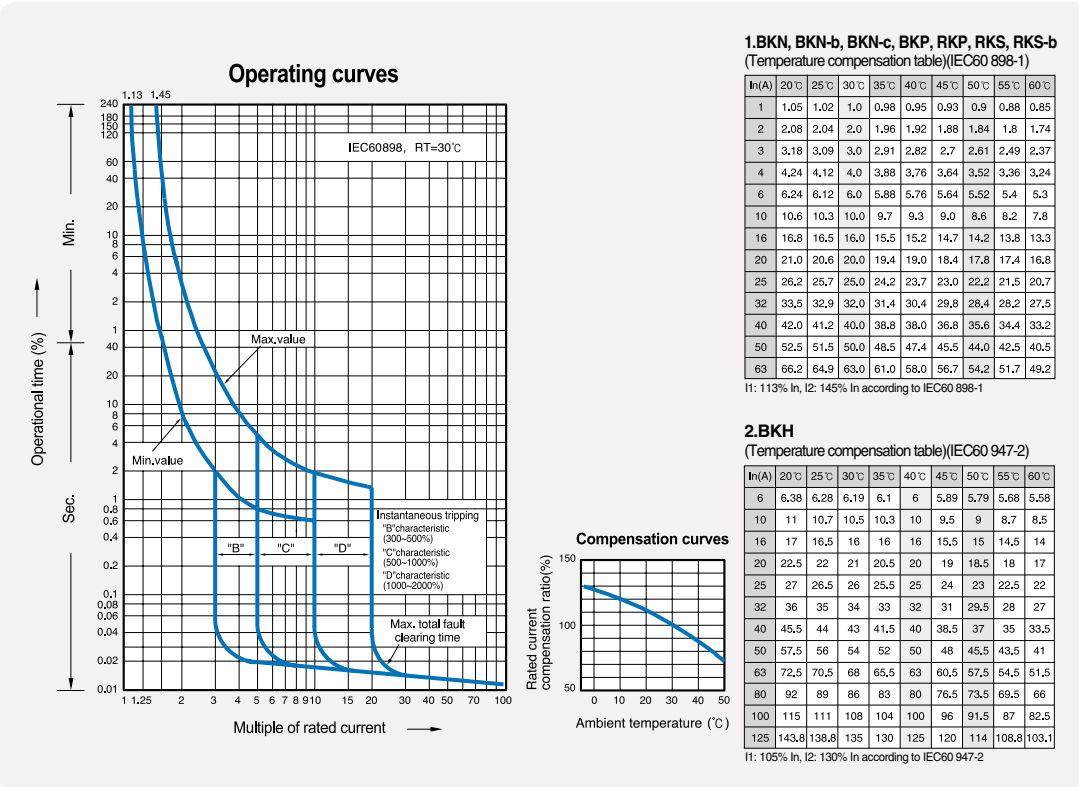

- 32KGRc
- 32KGRd

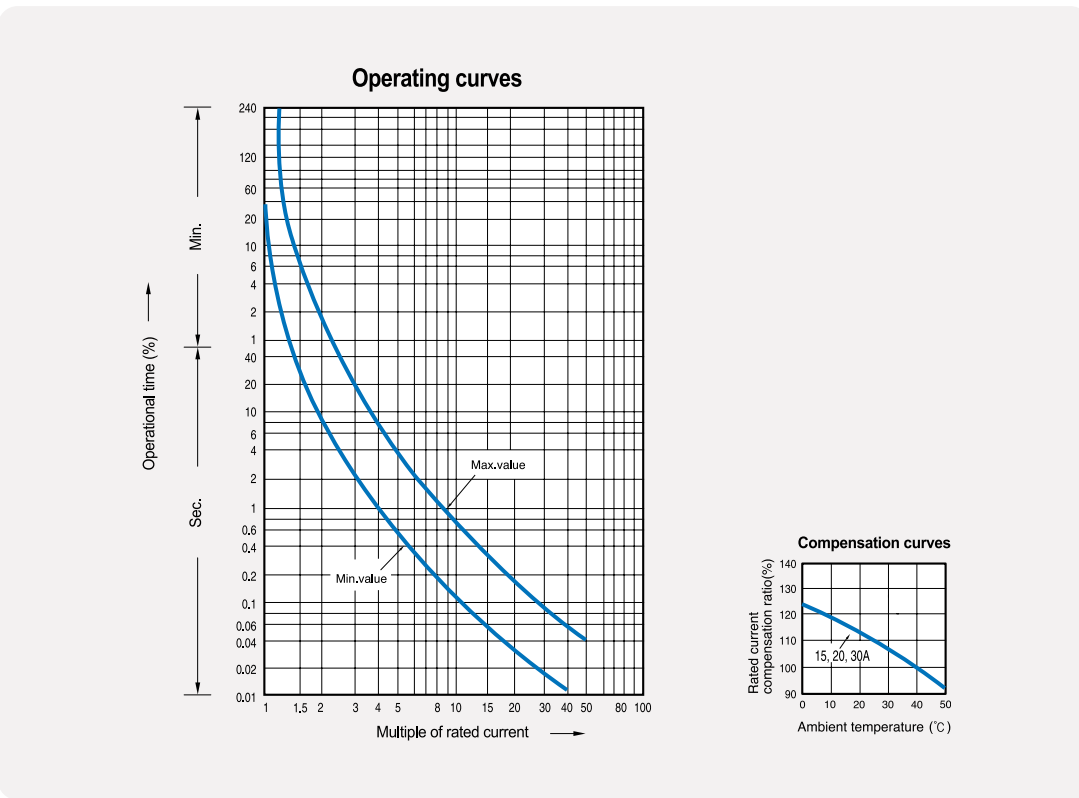

Operating curves & temperature compensation

BF-a

BF-c

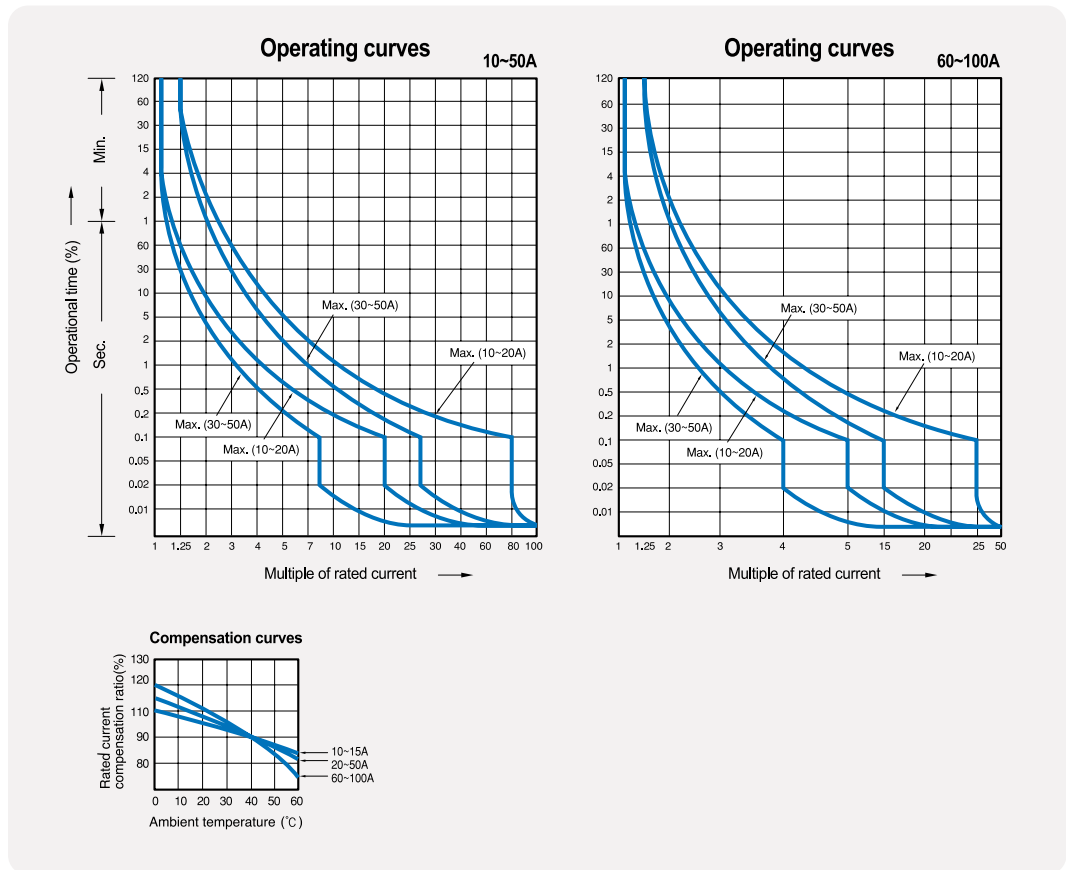

32GRhc

32GRhd

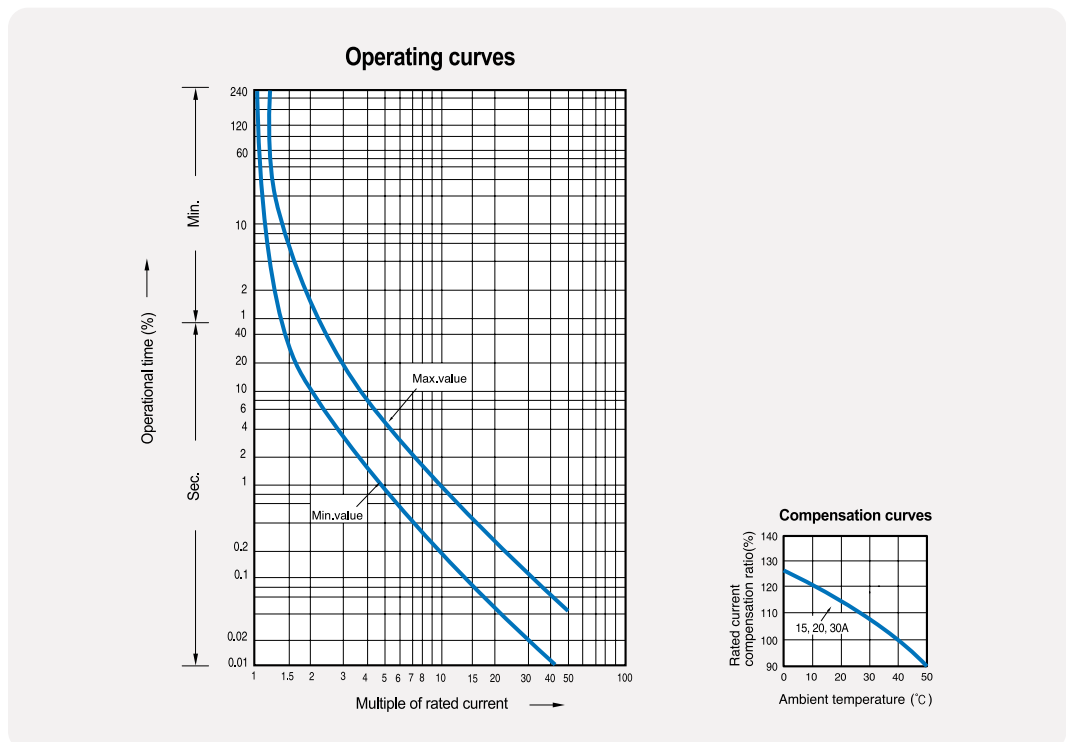

BFN

Operating curves

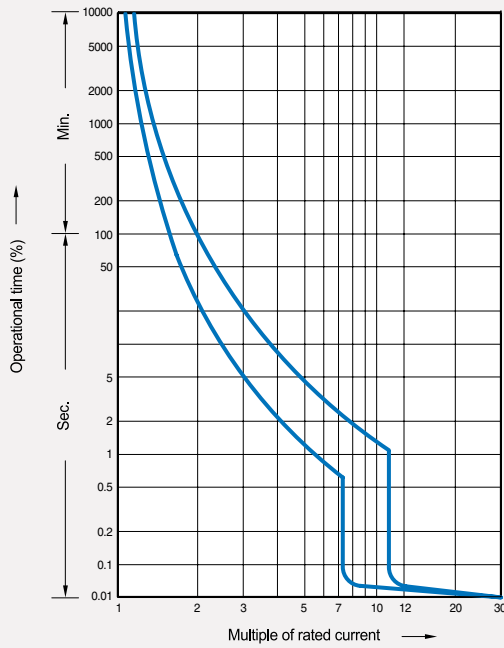

Temperature curve

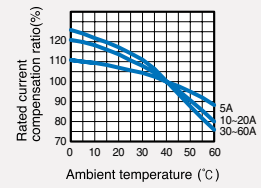

BS

Operating curves

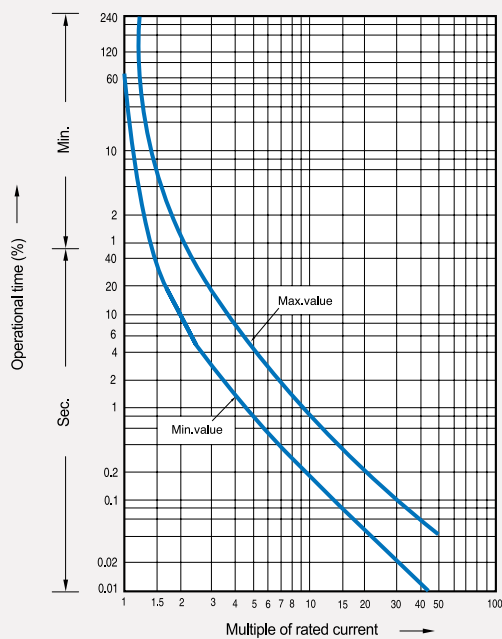

Compensation curves

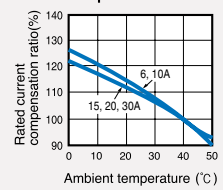

Overall dimensions

BKN

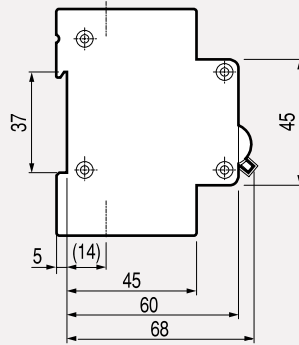

BKN-c

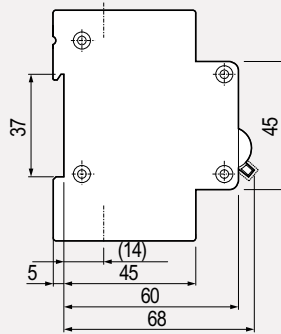

BKN-b

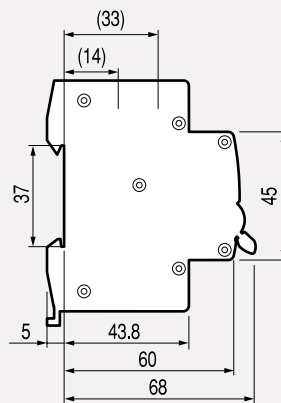

BKH

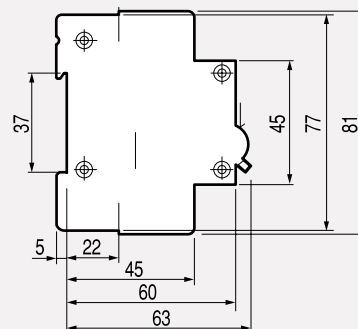

BKP

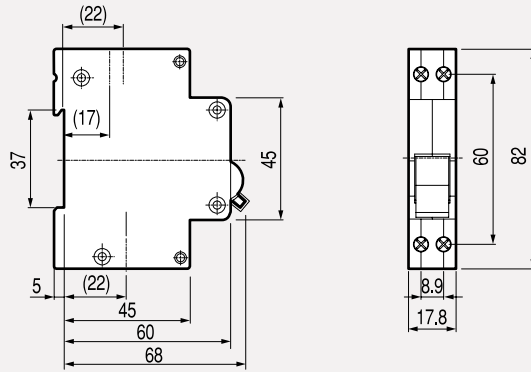

BFN

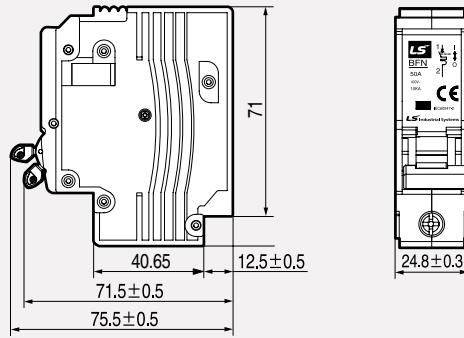

RKP

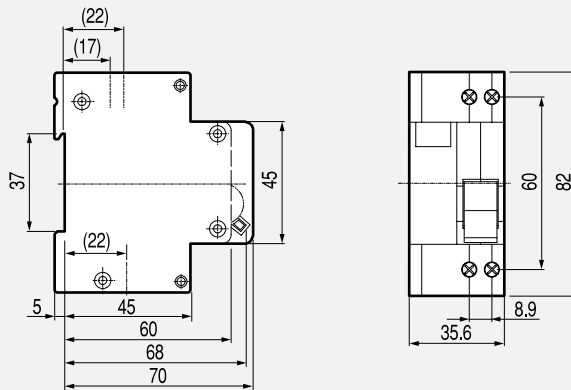

32KGRc/d

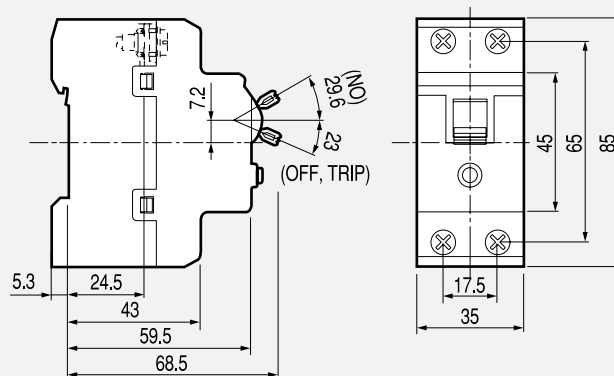

BF-a

BF-c

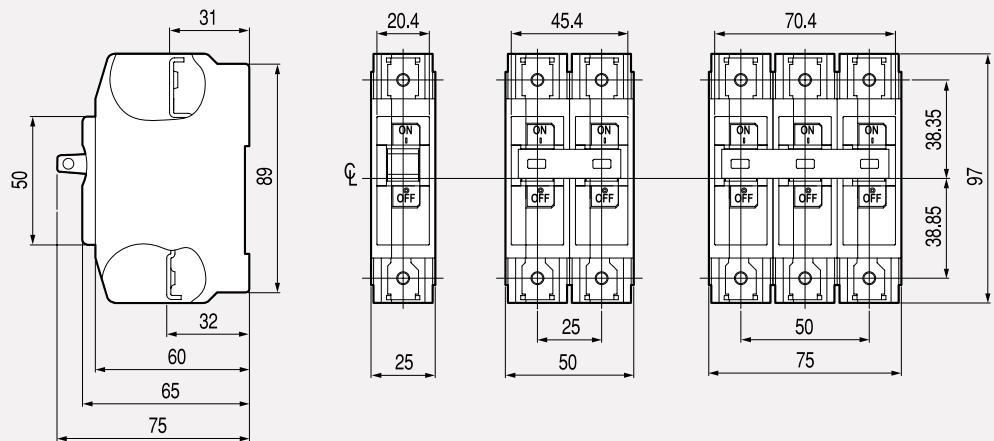

Detailed terminal

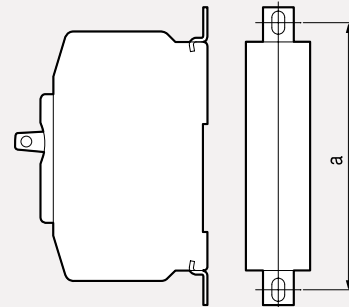
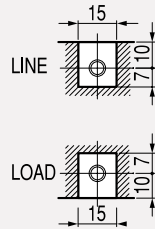

※ BFa, BFc same size (a=99~111mm)

32GRhc/d

BS

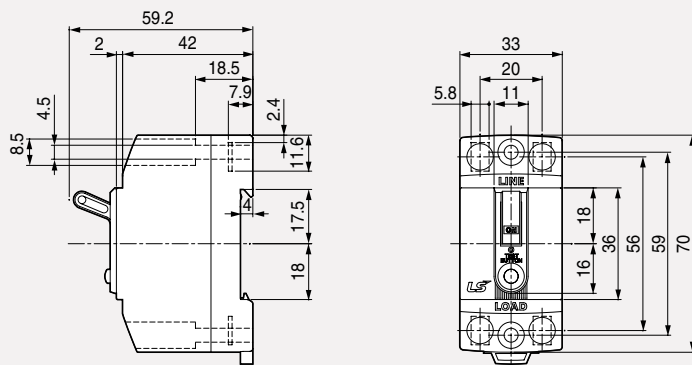

Internet information service

<http://eng.lsis.biz>



Should you require further information, please visit our English website (eng.lsis.biz).

You will find everything you need to know about products, systems and services.

To obtain the electronic catalogue,

please ask our authorized distributor in your country.

Or it is available on the internet (eng.lsis.biz).

A screenshot of the LSIS website displayed in a Microsoft Internet Explorer browser window. The browser title is "LSIS - Total Solution Provider - MCCB, MC, INVERTER, PLC - Microsoft Internet Explorer". The address bar shows "http://eng.lsis.biz/". The website features the LSIS logo and the slogan "Always with Our Customers!". A navigation menu includes "Products", "Support & Service", "Solution Guide", "R & D", and "About us". A prominent banner reads "New name, Fresh face Good Change! RoHS compliance". Below this, there are sections for "FEATURED PRODUCTS" (Susol series circuit breakers and Susol series Contactors & TOR) and "News" (dated 2006.04.30 and 2006.03.27). A "PRODUCT CATEGORY" sidebar lists various industrial systems like Low voltage, Medium voltage, and Protection & Measurement.

Related site

LS CABLE Home page www.lscable.com
 LS Nikko Home page www.lsnikko.com

Products menu

- Low voltage product
- Medium voltage product
- Protection & measurement
- Integrated protection & monitoring equipment
- PLC
- HMI
- Variable frequency device
- Electric power tools
- Switchgear
- Tranceformer
- High voltage product
- Process Automation
- ITS
- Railway system solution
- Photovoltaic system
- Tube & pipes

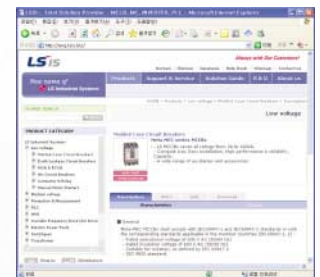

Support & service menu

- The latest catalogue and old editions are displayed and downloaded.

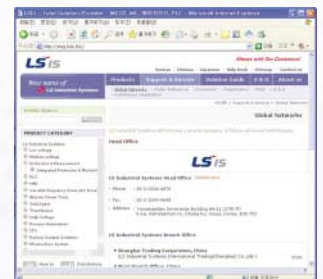

About us menu

- If you have a question, comment, suggestion please select this menu.

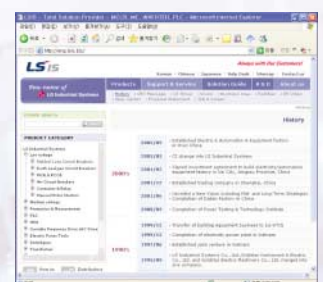

RoHS compliment menu

- RoHS : Directive on the Restriction of Hazardous Substances in the Electronic Equipment. (Effective on February 13.2003)

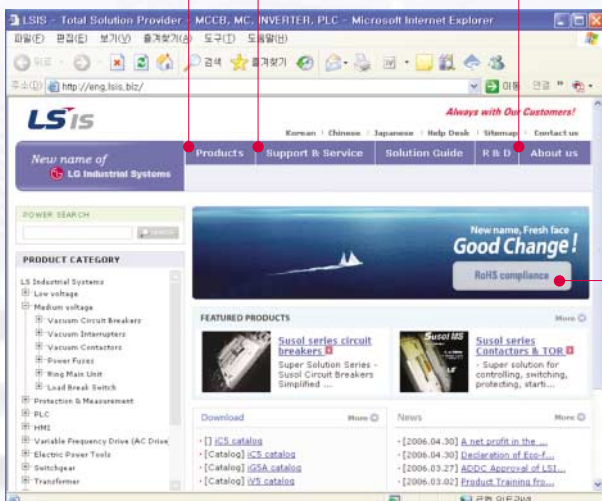
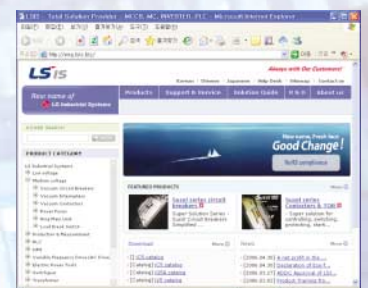

Green Innovators of Innovation



Safety Instructions

- For your safety, please read user's manual thoroughly before operating.
- Contact the nearest authorized service facility for examination, repair, or adjustment.
- Please contact a qualified service technician when you need maintenance. Do not disassemble or repair by yourself!
- Any maintenance and inspection shall be performed by the personnel having expertise concerned.

LSIS Co., Ltd.

© 2004.8 LSIS Co.,Ltd. All rights reserved.

www.lsis.biz

■ HEAD OFFICE

Korea Gyeonggi-do Anyang-si dongan-gu
LS-ro 127 (Hogyedong)

Tel. (82-2)2034-4887, 4873, 4148

Fax. (82-2)2034-4648

■ CHEONG-JU PLANT

Cheong-Ju Plant #1, Song Jung Dong, Hung Duk Ku,
Cheong Ju, 361-720, Korea

■ Global Network

- **LSIS (Middle East) FZE** >> **Dubai, U.A.E.**
Address: LOB 19 JAFZA VIEW TOWER Room 205, Jebel Ali Freezone P.O. Box 114216, Dubai, United Arab Emirates
Tel: 971-4-886 5360 Fax: 971-4-886-5361 e-mail: jungyongl@lsis.biz
- **Dalian LSIS Co., Ltd.** >> **Dalian, China**
Address: No.15, Liaohexi 3-Road, Economic and Technical Development zone, Dalian 116600, China
Tel: 86-411-8273-7777 Fax: 86-411-8730-7560 e-mail: lixx@lsis.com.cn
- **LSIS (Wuxi) Co., Ltd.** >> **Wuxi, China**
Address: 102-A, National High & New Tech Industrial Development Area, Wuxi, Jiangsu, 214028, P.R.China
Tel: 86-510-8534-6666 Fax: 86-510-522-4078 e-mail: xuhg@lsis.com.cn
- **LSIS-VINA Co., Ltd.** >> **Hanoi, Vietnam**
Address: Nguyen Khe - Dong Anh - Ha Noi - Viet Nam
Tel: 84-4-882-0222 Fax: 84-4-882-0220 e-mail: srjo@lsisvina.com
- **LSIS-VINA Co., Ltd.** >> **Hochiminh, Vietnam**
Address: 41 Nguyen Thi Minh Khai Str. Yoco Bldg 4th Floor, Hochiminh City, Vietnam
Tel: 84-8-3822-7941 Fax: 84-8-3822-7942 e-mail: sbpark@lsisvina.com
- **LSIS Shanghai Office** >> **Shanghai, China**
Address: Room E-G, 12th Floor Huamin Empire Plaza, No.726, West Yan'an Road Shanghai 200050, P.R. China
Tel: 86-21-5237-9977 (609) Fax: 89-21-5237-7191 e-mail: jinhk@lsis.com.cn
- **LSIS Beijing Office** >> **Beijing, China**
Address: B-Tower 17FL.Beijing Global Trade Center B/D. No.36, BeiSanHuanDong-Lu, DongCheng-District, Beijing 100013, P.R. China
Tel: 86-10-5825-6025,7 Fax: 86-10-5825-6026 e-mail: cuixiaorong@lsis.com.cn
- **LSIS Guangzhou Office** >> **Guangzhou, China**
Address: Room 1403,14F,New Poly Tower,2 Zhongshan Liu Road,Guangzhou, P.R. China
Tel: 86-20-8326-6764 Fax: 86-20-8326-6287 e-mail: linsz@lsis.biz
- **LSIS Chengdu Office** >> **Chengdu, China**
Address: Room 1701 17Floor, huanminhanjun international Building, No1 Fuxing Road Chengdu, 610041, P.R. China
Tel: 86-28-8670-3101 Fax: 86-28-8670-3203 e-mail: yangcf@lsis.com.cn
- **LSIS Qingdao Office** >> **Qingdao, China**
Address: 7B40,Haixin Guangchang Sheny Building B, No.9, Shandong Road Qingdao 26600, P.R. China
Tel: 86-532-8501-6568 Fax: 86-532-583-3793 e-mail: lirj@lsis.com.cn
- **LSIS NETHERLANDS Co.Ltd** >> **Netherlands**
Address: 1st. Floor, Tupolevlaan 48, 1119NZ,Schiphol-Rijk, The Netherlands
Tel: 31-20-654-1420 Fax: 31-20-654-1429 e-mail: junshickp@lsis.biz
- **LSIS Gurgaon Office** >> **Gurgaon, India**
Address: 109 First Floor, Park Central, Sector-30, Gurgaon- 122 002, Haryana, India

Specifications in this catalog are subject to change without notice due to continuous product development and improvement.